





CONTENTS

→ 01	Who are we?	05
	About Grad	06
→ 02	The Grad System	09
→ 03	Non-structural rails	16
	Flat Rail	18
	Start rail	19
	Mini Rail	20
→ 04	Structural rails	21
	PR24	22
	PR39	23
	Installation Type	24
	Made-to-Order	26
	Accessories	27
	Finishing Touches	28
	Other Applications	34
→ 05	Cladding Boards	37
	Thermo Spruce	38
	Thermo Clear Pine	40
	MOSO®	42
	Thermo Ash	44
	Kebony®	46
	Accoya®	48
	Aluminium	50
	Compatibility Table	51
→ 06	Featured Projects	53



Flat rail / Thermo Ash / © Carpentier

→ 01

WHO ARE WE?

Who are we?
About Grad and Burger & Cie.

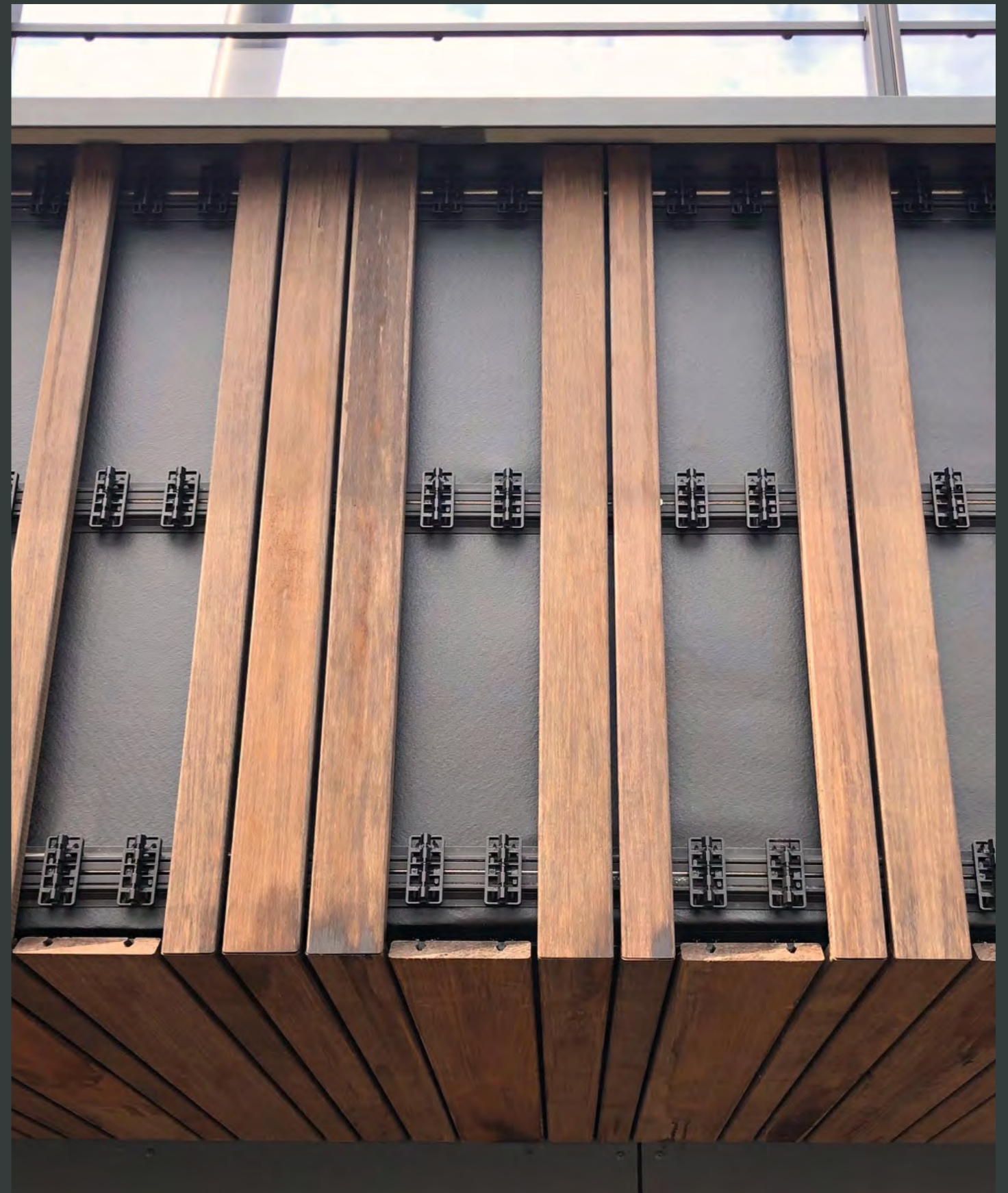

WHO ARE WE?

For almost 20 years, the Grad® team has been perfecting the invisible fastening system with the Grad® Clip.

Through the spirit of innovation, the vision of a sustainable product and the experience gained from our customers, Grad® continues to develop its intelligent, versatile and easy-to-use system.

Thanks to the inventiveness, aestheticism and durability of the product, over the years Grad® has established itself as a product of excellence, of interest to end users, landscapers and architects alike.

It is thanks to its solid foundations and dedicated teams that Grad is exporting all over the world to seduce and convince new users.

OUR ENGAGEMENTS

Environment.

Grad® shows its commitment to the future through several actions:

- In the design of our products, we choose to work with recycled and recyclable materials. The aluminium used for the rails is >80% recycled aluminium and is 100% recyclable. The plastic used for the injection of accessories and clips is 100% recyclable.
- Our factory is heated with wood chip waste from our production.
- Production made to order.
- Long product life expectancy (20 years) to avoid replacements.
- We favour short supply chains for the procurement of our raw materials.

OUR SERVICES

Warranties.

All products manufactured by Grad® (rails and accessories) are guaranteed for 20 years.

Commercial management.

At Grad®, we take special care of our partners. That is why each partner customer benefits from a dedicated sales representative as well as a key contact at the head office to ensure a constant service rate and availability. We are convinced that commercial relations must be based on dedicated and available customer service representatives.

Grad3D.

We provide our partners with the drawing software Grad3D to allow you to draw and prepare your commercial offers.

In addition, two collaborators at the head office are specialized to train and accompany you in the handling of the tool and in its use.

Design office.

Grad® has a team of product technicians at your disposal to accompany you in your project studies.

Through our internal tool, Grad3D, for residential projects of decking and cladding, or tools like AutoCAD and REVIT for larger scale projects.

We are able to develop all of your custom and most daring projects.

Training.

To allow our partners to fully develop their potential, we set up the Grad® Academy, a multi-stage training course to fully understand the Grad® system, its products, its advantages and its technicalities.

Whether you have a question about the system, sales techniques, installation, or a need for the design software, we will accompany you in your global understanding of Grad®.

BURGER & CIE

Founded in 1847 as a family company, now run by the 6th generation, Burger & Cie has written an exceptional French industrial saga from its Alsatian birthplace in the "Val d'Argent", halfway between Strasbourg and Mulhouse, France.

Today, the Burger & Cie group is asserting its unique expertise in the art of timber works, while cultivating its difference as an independent company focused on innovation, with an integrated Research and Development (R&D) department.

A major European name in interior and exterior wood products, the company that dreamt up and created the Booa archi-design houses has always been able to adapt, seize opportunities and negotiate the changes in direction.

In 2017, we invested in a new digital machine that works with aluminium to manufacture our rails, following the award of a new contract with one of Europe's largest DIY groups. This ability to constantly take on new challenges is inherent in Burger's strength and identity.



GROUP:



430 EMPLOYEES

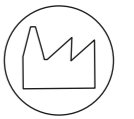

2 SITES



4 BRANDS



120 MILLION TURNOVER

LIÈPVRE, FRANCE:



230 EMPLOYEES

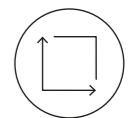

10 HECTARES

→ grad kordo. jardipolys

CHÂTENOIS, FRANCE:



200 EMPLOYEES

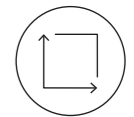

5 HECTARES

→ booa♥

KEY PRODUCTION FIGURES:

21 KM OF RAILS/DAY

140 000 CLIPS/DAY

17 280 PEDESTALS/DAY



MOSO® Bamboo X-treme® / Flat rail / © TIM Exclusive Gardens



PR24 / Thermo Limba / © Mark Verwey Photography

→ 02

THE GRAD® SYSTEM

About
The Grad System

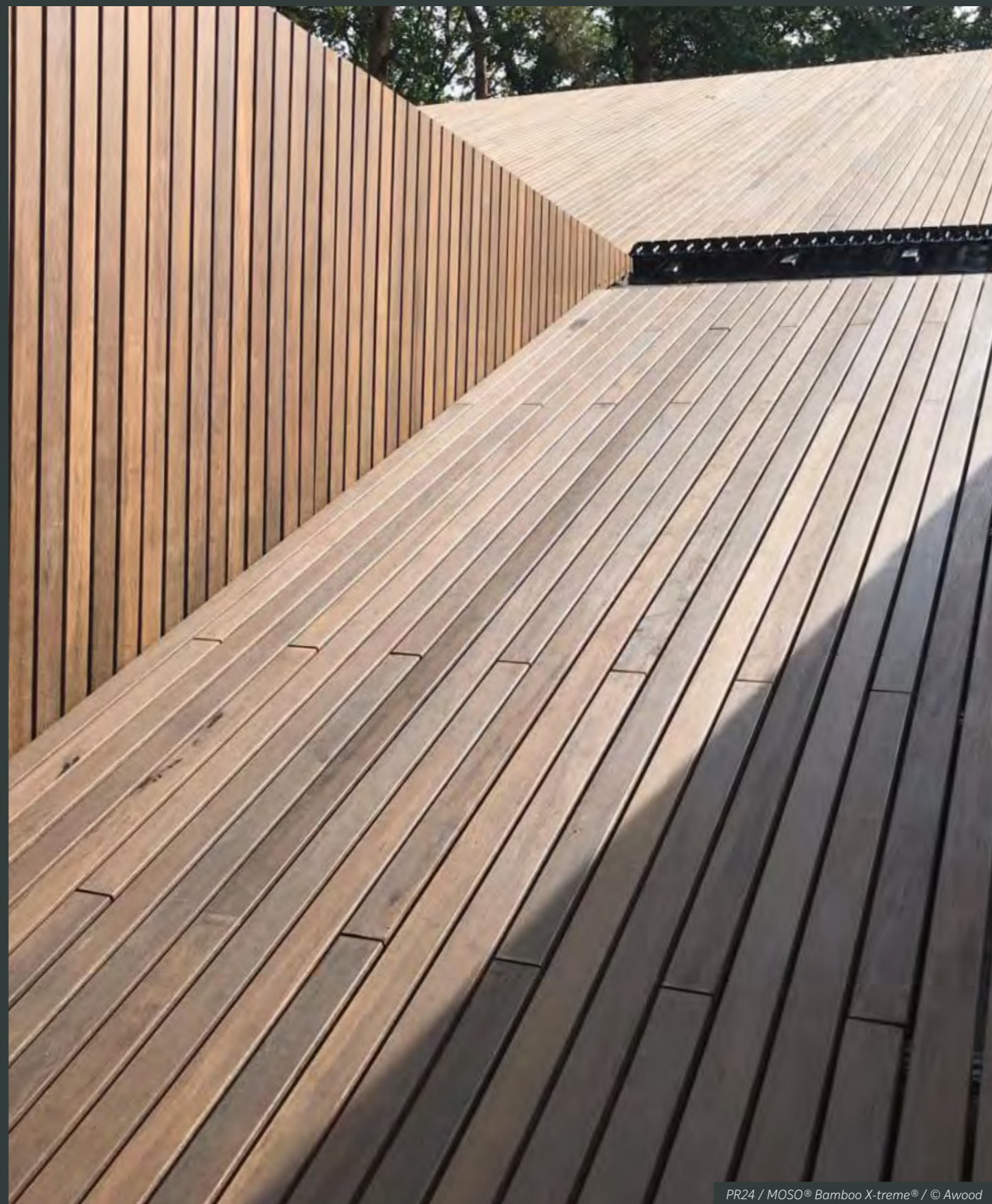

PR24 / MOSO® Bamboo X-treme® / © Awood

THE HEART OF OUR SYSTEM

ALUMINIUM

The 6060 alloy used for Grad® rails has excellent mechanical properties for structural use, **allowing the systems to be installed in façades even in very exposed environments.** This alloy also has a very good resistance to corrosion in outdoor environments near the seaside and in swimming pool areas.

RECYCLING INTERNAL SCRAP METAL

Thanks to its high recycling capacity, aluminium is a real energy asset and is integrated into the heart of the circular economy. Recycling is essential, so we apply the necessary sorting instructions to **give new life to aluminium scrap.**

RECYCLED & RECYCLABLE

Because it can be recycled over and over again, aluminium saves 95% of the energy and 70% of the water needed to produce primary aluminium. Since aluminium does not lose any of its qualities during the recycling process, **this material makes it possible to approach the goal of zero waste in the long term.**

ENVIRONMENT

We manufacture products whose recycling and re-use of materials **minimize the environmental footprint and preserve natural resources.**

EUROPEAN FABRICATION

THE GRAD® CLIP

Injected from **POLYOXYMETHYLENE**

INVISIBLE FASTENING SYSTEM

For cladding, the Grad system is recognized as complying with the requirements of DTU 41-2 for ventilated cladding.

EASILY DETACHABLE WITH KEYS

It is as easy to unclip a board as to clip it, thanks to keys developed to pass between 2 boards, and to insert between the aluminium rail and the lugs of the clips. The boards, clips and frame are not damaged, everything is re-positionable without difficulty.

RESOURCE EFFICIENCY

Burger has undertaken the renewal of its injection moulding machine park: the energy-intensive hydraulic presses have been replaced by low-consumption electric presses. In addition, air heaters have been installed in the injection moulding shop to heat the production area with the heat recovered from the cooling circuit of the injection moulding machines.



100% RECYCLABLE

100% FRENCH FABRICATION

Made in Alsace

RESISTANT

The Grad system has been tested in the lab and, thanks to its high tensile strength, it can be used on buildings of 10 m and 28 m in areas that are highly exposed to wind.



ABOUT OUR SYSTEM

A CLOSER LOOK

Performance & certifications

The Grad cladding solution guarantees you the best possible performance. From future-proof design, to perfect finishes, by way of quick and easy installation, we strive every day to improve our system so that it performs even better, while complying with current standards.

What's more, we attach great importance to ensuring that our system complies with the requirements of the circular economy. For this reason, it has been designed to be dismantled and reused, so that end-of-life or damaged blades can be replaced, while using recycled and/or recyclable materials to guarantee a structure that performs well for 20 years.

Sustainability & CSR

The timber industry is at the heart of our business and our concerns.

The origin of our wood and the way it is processed are key criteria when we select our supply sources. That's why our entire supply and production chains are based on responsible forest management systems. We prioritize wood species from well-managed forests, with their origin and the traceability system validated by approved third-party organisations. This is an environmental commitment that we promote to preserve natural forest resources.

100% invisible fixing, a unique & patented system.

- + 100% invisible fixing
- + unrivalled reduction in installation time
- + installation on all types of walls
- + no damage to the surface of the boards
- + perfect drainage lines
- + complies with the requirements of DTU 41-2

- + 20-year structural guarantee
- + can be completely dismantled for use with ventilated ventilated cladding.
- + many compatible materials for cladding profiles
- + structure 100% made in France

ALUMINIUM RAILS

5 profiles with different characteristics to adapt to all requirements

Perfect Alignment & Optimal Stability.

Grad Clips are pre-fitted to aluminium rails in our factory according to your project. Each installation has its own type of rail, and its features and accessories mean that every possible configuration can be achieved, in terms of both boards and finishes. Grad Clips installed on automated production lines: a unique concept in pre-fitted rails!

Structural guarantee.

Thanks to our concept, our cladding is more durable because there are no points of weakness, the boards are not in direct contact with the framework, and the space between the boards is guaranteed, so no water infiltration is possible.

Perfect Finish.

An impeccable finish thanks to invisible fixations, with no screws to hold the cladding boards in place.

Adapted for the Grad Clip.

Since 2005, our R&D team has been developing and improving the groove system so that it fits perfectly with the Grad Clip. In this way, all grooved boards that we have tested and approved become compatible with our invisible fastening system.

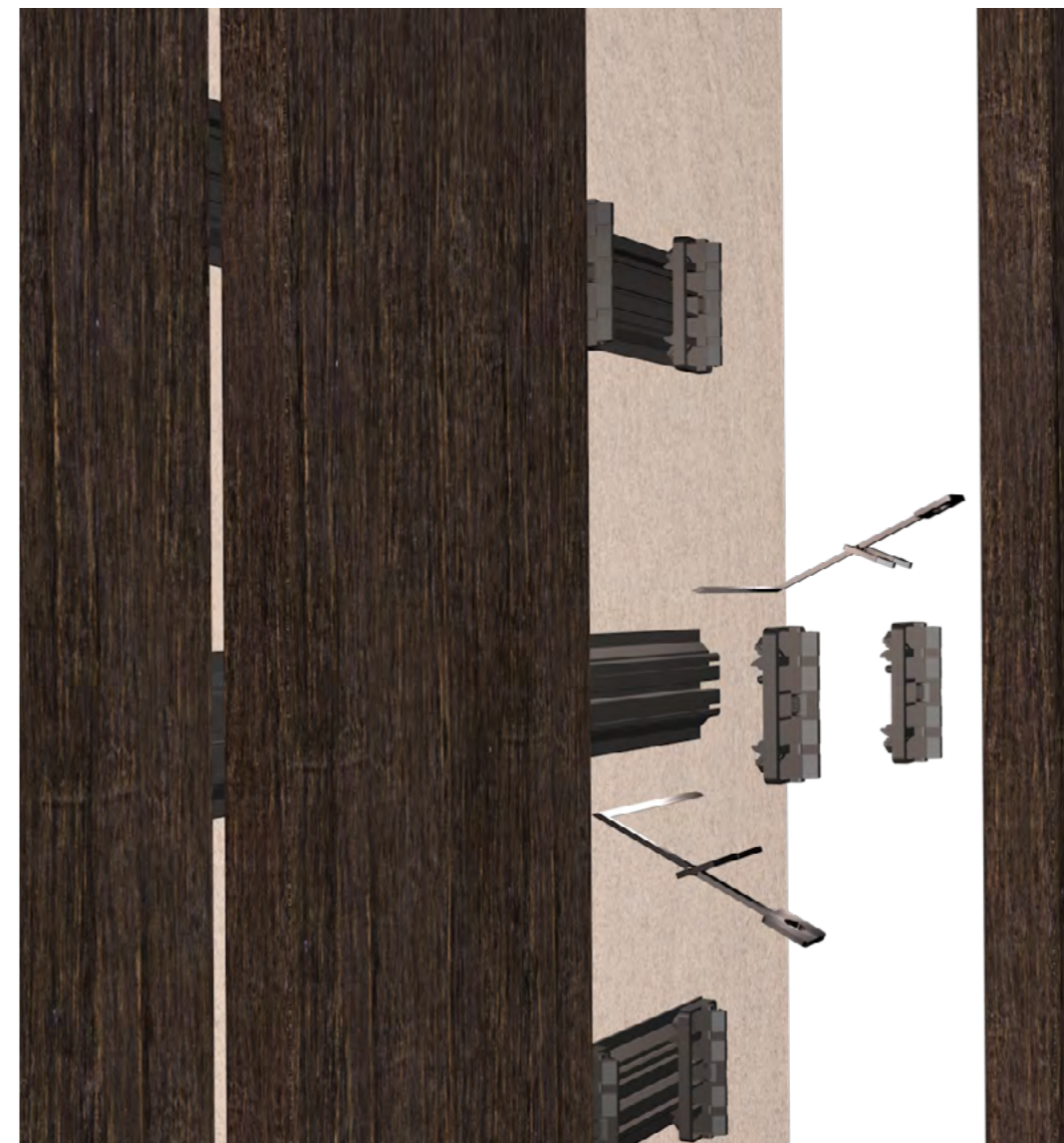
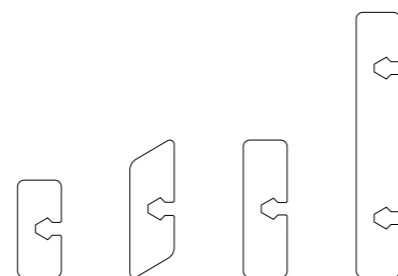

100% REMOVABLE
board by board, for open cladding projects, thanks to our **DISMANTLING KEYS**



PRE-INSTALLED CLIPS, PLACED TO ORDER

to fix compatible boards with a simple push, without any screws



Start Rail / Thermo Ash / © Jakobson

FOR INSTALLERS

→ **ALIGNMENT** : thanks to our factory-fitted clips, which are matched to the selected cladding boards, it's possible to achieve even spacing between the boards at all times. The result is perfect alignment throughout the façade.

→ **EASE OF INSTALLATION**: the positioning of the clips is precisely controlled at our factory, giving the installer unrivalled ease of installation. A simple press is all it takes to snap the board into place. The aluminium structure is lightweight and its rectitude makes it easy to align the profiles.

→ **STABLE WOODS**: the wooden boards selected by our R&D department are more durable and stable than the vast majority of boards on the market.

→ **DESIGNED AND PRODUCED IN FRANCE**: patented since 2014, the latest version of the Grad system is manufactured at our Lièpvre site using state-of-the-art automated production lines.

→ **TECHNICAL SOLUTIONS**: with installation guides, technical data sheets, free project quotes, and dedicated representatives, our teams are ready to assist you with any needs, and in your learning about and perfecting of the Grad® system.



Flat rail / MOSO® Bamboo X-treme® / © Bart Van Spee

AND CONSULTANTS

→ **UNLIMITED DESIGN POSSIBILITIES**: thanks to the pre-mounted clips on automated production lines, it is possible to vary the spacing of the boards or the width of the profiles to achieve the desired aesthetic for the façade.

→ **MANY POSSIBLE BOARD COLOURS, WOODS, AND STYLES** : In addition to dimensional variations, the Grad System allows the use of a wide variety of materials: softwood, hardwood, bamboo, aluminium and medium-density fibreboard.

→ **OUR DESIGN OFFICE** is at your disposal to help you with your projects. From defining your requirements in terms of technical constraints to producing working drawings, we are at your side to provide you with the best possible support. Our products are available in BIM format and can be integrated with REVIT design software.

→ **A CAREFULLY CONSIDERED AND EASY TO LEARN SYSTEM** designed to eliminate errors during installation. Perfect alignment, a flawless surface, and quick installation are the signatures of the Grad System.

→ **ENHANCED MATERIALS**: no punctures on the surface of the cladding, no clips in between the boards.

→ **SUSTAINABLE DEVELOPMENT**: our CSR policy has been in place for several years and is at the heart of both our history and our product development. With products made from recycled and recyclable materials, aluminium rails that last and are easy to recycle, and cladding boards from responsible sources, we are committed every day to strengthening our sustainability credentials.

→ **CERTIFICATIONS**: our factory is FSC® certified and our products benefit from numerous certifications and meet regulatory standards.

→ **DURABILITY**: our constant quest to ensure the durability of our structures has led us to select the best-performing materials: Rot-proof aluminium structure, high-strength plastic clips, durable cladding boards.

→ **MAINTENANCE**: our products can be dismantled for easy maintenance. The boards can be removed and reinstalled without any loss of material, using specially designed dismantling keys.

→ **CONTINUING SUPPORT**: our sales and support teams are available to help you with any needs, anywhere in the world.

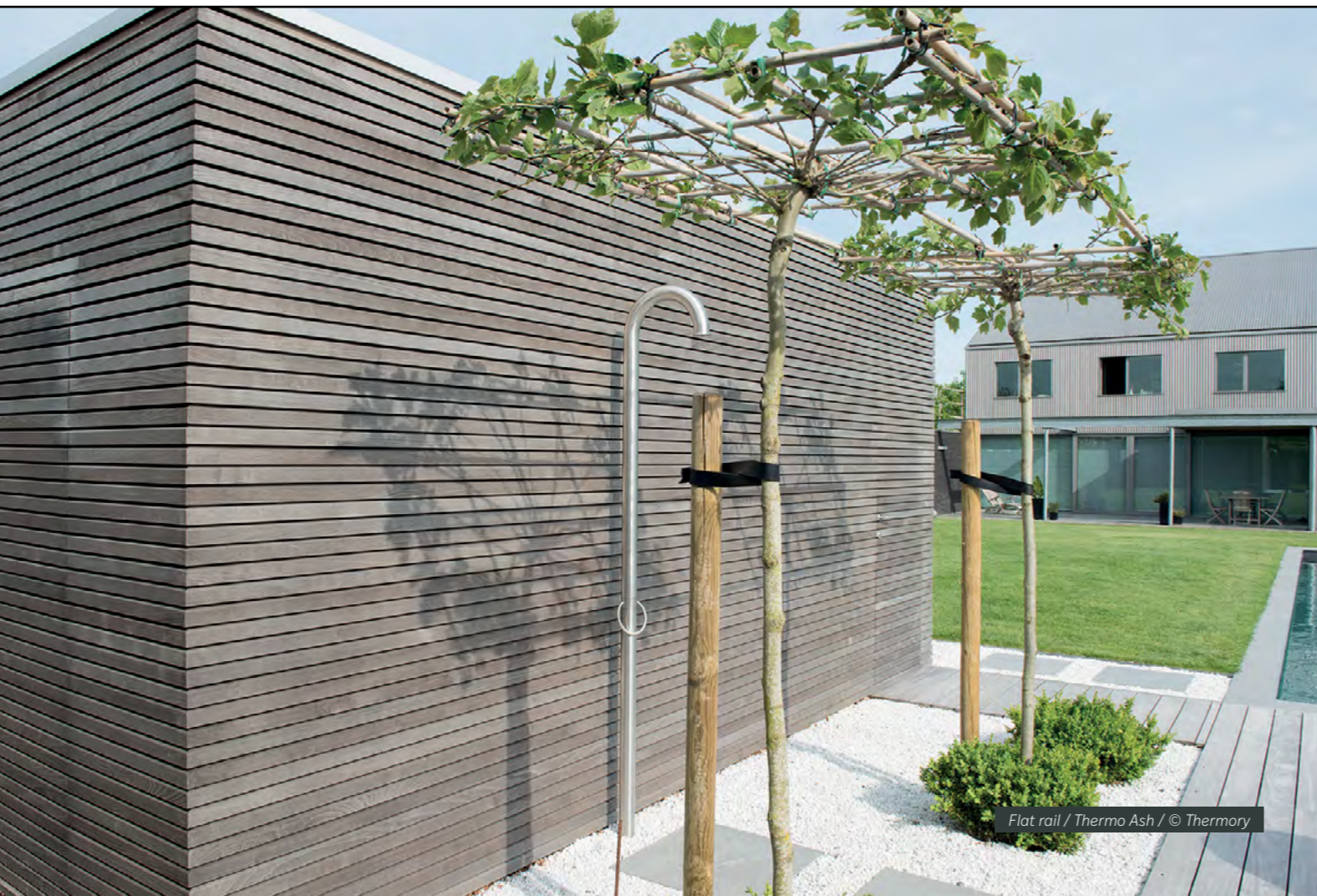

Flat rail / Thermo Ash / © Thermory



Flat rail / Thermo Ash / Carpentier / ©Buro Ruijs and Hans Gorter

NON-STRUCTURAL RAILS

Technical characteristics
Useful information

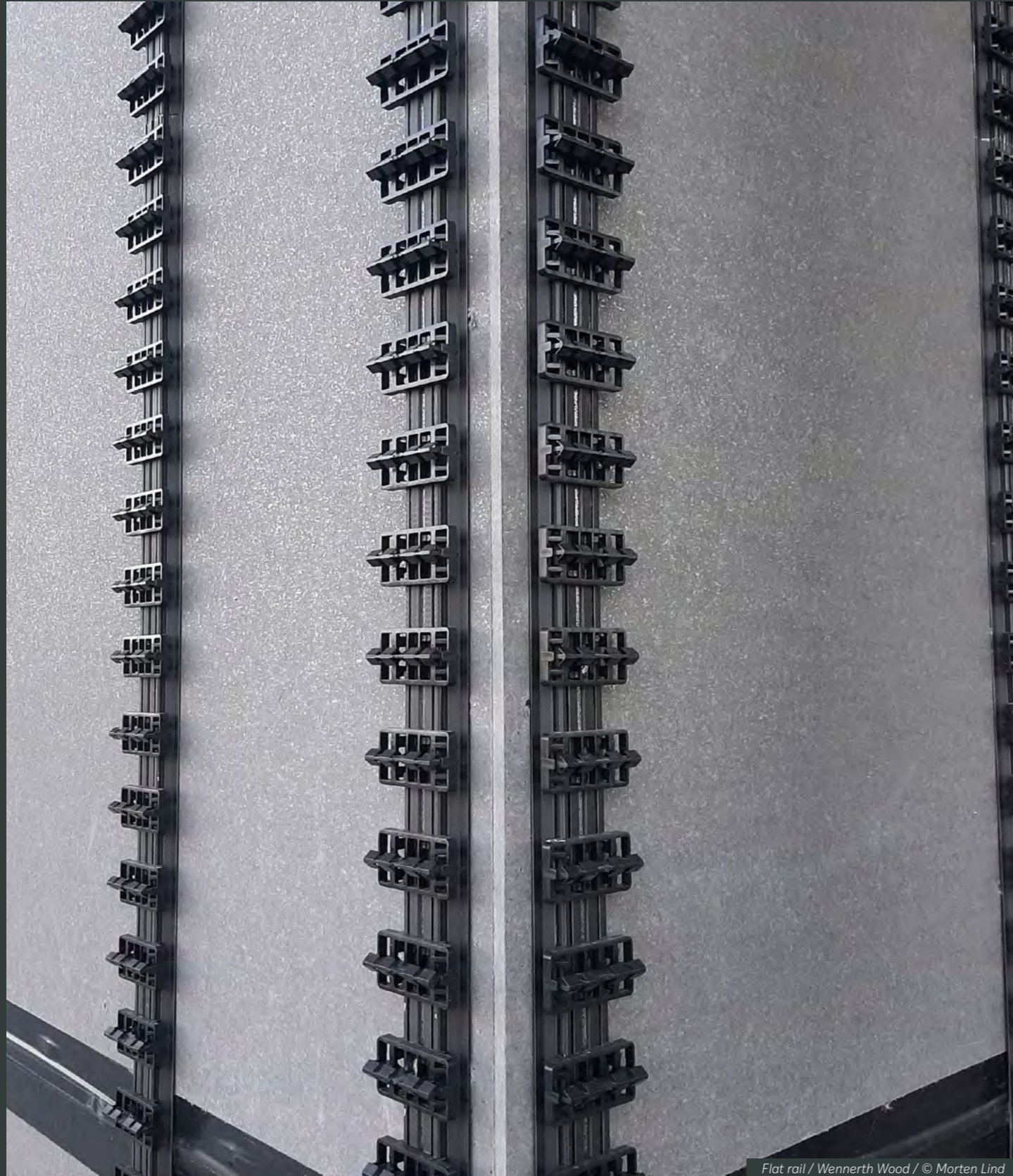

Flat rail / Wennerrth Wood / © Morten Lind

FLAT RAIL

Non-structural rail for installing exterior cladding, soffits, roofing, ceilings, and interior panelling.

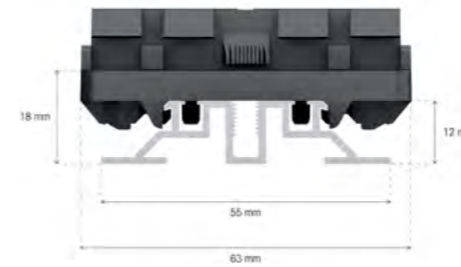

REF	DESCRIPTION	QTY/PALETTE	CONSUMPTION INDICATIVE PER M ²
1185	FLAT RAIL - clip spacing 124 mm 32 clips for 16 boards of 120 mm 12 x 55 x 1984 mm.	216 pcs	0,85 pc
1187	FLAT RAIL - clip spacing 71 mm 28 clips for 28 boards 12 x 55 x 1988 mm.	216 pcs	0,85 pc
1188	FLAT RAIL - clip spacing 56 mm 35 clips for 35 boards 12 x 55 x 1960 mm.	216 pcs	0,85 pc
1792	FLAT RAIL - clip spacing 70 mm 28 clips for 28 boards 12 x 55 x 1960 mm.	216 pcs	0,85 pc
1799	FLAT RAIL - clip spacing 51 mm 39 clips for 39 boards 12 x 55 x 1989 mm.	216 pcs	0,85 pc
1822	FLAT RAIL - clip spacing 69 mm 29 clips for 29 boards 12 x 55 x 2001 mm.	216 pcs	0,85 pc
2480	FLAT RAIL - VARIBO 32 clips for 25 boards 12 x 55 x 1968 mm.	216 pcs	0,85 pc
2191	FLAT RAIL - clip spacing 46 mm 43 clips for 43 boards 12 x 55 x 1978 mm.	216 pcs	0,85 pc
2632	FLAT RAIL - clip spacing 58,5 mm 34 clips for 34 boards. 12 x 55 x 1989 mm.	216 pcs	0,85 pc

TECHNICAL CHARACTERISTICS

Rail material	Aluminium 6060
Rail finish	Black paint
Clip material	Polyoxymethylene (POM)
Rail weight (including clips)	+/- 0,630 kg/ml
Maximum length	3968 mm
Pull-out strength of the clip on the rail	150 to 250 kg, for two fixing points (depending on the type of board)

- Thin: only 38 mm thick including a 20 mm thick board
- Simple, quick and easy to install
- Light : 630 gr/ml
- Industrially pre-clipped rail for perfect drainage lines
- Each board can be removed individually with special keys adapted to the width of the board
- Rail can be cut to length
- No contact between the boards and the aluminium rail for better air circulation
- Invisible fastening
- Simple, quick and comfortable installation
- Endless possibilities
- 100% recyclable

START RAIL

Non-structural rail for cladding and soffit applications.

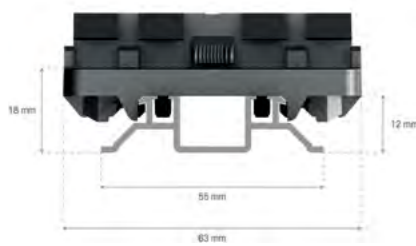
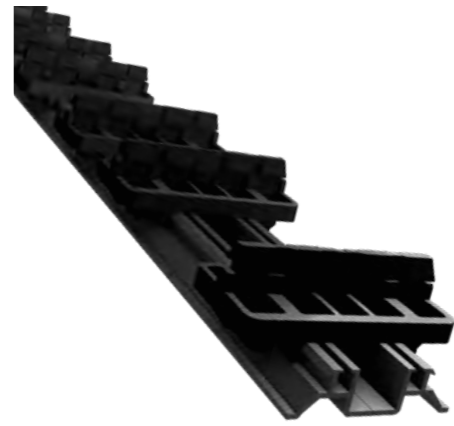

TECHNICAL CHARACTERISTICS

Rail material	Aluminium 6060
Rail finish	Black paint
Clip material	Polyoxymethylene (POM)
Rail weight (including clips)	+/- 0,508 kg/ml
Maximum length	1984 mm
Pull-out strength of the clip on the rail	150 to 250 kg, for two fixing points (depending on the type of board)

- Thin, light profile
- Easy, quick and comfortable to install
- Industrially pre-clipped rail for perfect drainage lines
- Each board can be removed individually with special keys adapted to the width of the board
- Rail can be cut to length
- No contact between the boards and the aluminium rail for better air circulation
- Invisible fastening
- Simple, quick and comfortable installation
- Endless possibilities
- 100% recyclable
- References made to order

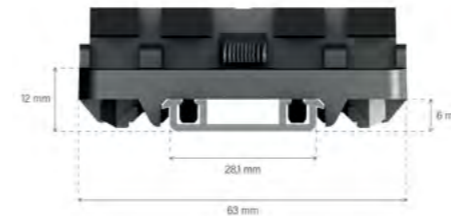

MINI RAIL

Non-structural rail for cladding and soffit applications.

TECHNICAL CHARACTERISTICS

Rail material	Aluminium 6060
Rail finish	Black paint
Clip material	Polyoxymethylene (POM)
Rail weight (including clips)	+/- 0,383 kg/ml
Maximum length	1984 mm
Pull-out strength of the clip on the rail	150 to 250 kg, for two fixing points (depending on the type of board)

Attention: this rail is not compatible with our dismantling keys.

- Very thin profile
- Easy, quick and comfortable to install
- Industrially pre-clipped rail for perfect drainage lines
- Rail can be cut to length
- No contact between the boards and the aluminium rail for better air circulation
- Invisible fastening
- Endless possibilities
- 100% recyclable
- References made to order



It is possible to install the Mini Rail on a curve



→ 04

STRUCTURAL RAILS

Technical characteristics
Useful information



Flat rail / Thermo Pine / © Thermory®



PR24 / Thermo Limba / © Mark Verwey Photography



PR24

Structural rail for installing exterior cladding, soffits, and ceilings
Up to 1.35 m between fixations*

TECHNICAL CHARACTERISTICS

Rail material	Aluminium 6060
Rail finish	Black paint
Clip material	Polyoxymethylene (POM)
Rail weight (including clips)	+/- 1,07 kg/ml
Max length. PR24 - 56/71	3968 mm
Pull-out strength of the clip on the rail	150 to 250 kg, for two fixing points (depending on the type of board)

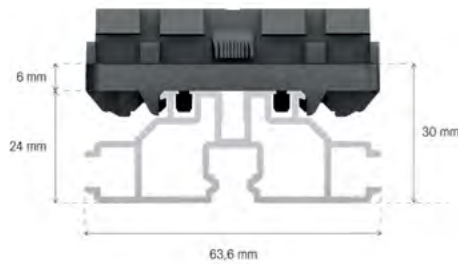

- Industrially pre-clipped profile for perfect drainage lines
- Simple, quick and easy to install
- Each board can be dismantled individually using special keys adapted to the width of the board
- Rail can be cut to length on site
- No contact between the boards and the aluminium rail, for better air circulation
- Invisible fastening
- Endless possibilities of use
- 100% recyclable
- Lightweight: 1.07 kg/ml
- Straight: perfect straightness for alignment and levelling



PR24 / Thermo Limba / © Mark Verwey Photography

*according to calculations available on our website

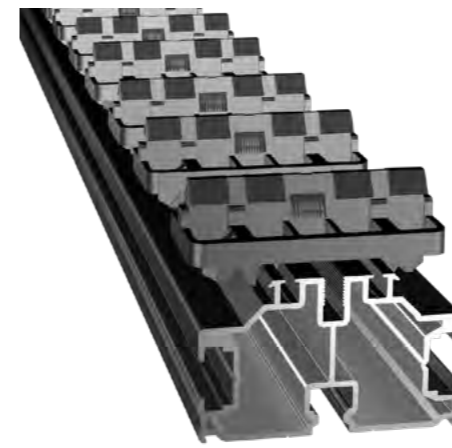

PR39

Structural rail for installing exterior cladding, soffits, and ceilings
Up to 1.35 m between fixations*

TECHNICAL CHARACTERISTICS

Rail material	Aluminium 6060
Rail finish	Black paint
Clip material	Polyoxymethylene (POM)
Rail weight (including clips)	+/- 1,43 kg/ml
Max length. PR39 - 56/71	3968 mm
Pull-out strength of the clip on the rail	150 to 250 kg, for two fixing points (depending on the type of board)

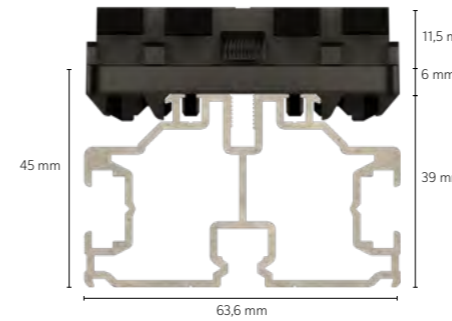

- Industrially pre-clipped profile for perfect drainage lines
- Simple, quick and easy to install
- Each board can be removed individually using our special keys (depending on board profile)
- No contact between the aluminium profile and the facing boards, for improved ventilation
- Rail can be cut to length
- Invisible fixing
- Infinite possibilities
- 100% recyclable



PR24 / Thermo Limba / © Mark Verwey Photography

*according to calculations available on our website

INSTALLATION CONFIGURATIONS

The Grad® system can be used for horizontal and vertical cladding, soffits, and ceilings, even in areas subject to high wind speeds.

Grad aluminium profiles can be installed on all surfaces: concrete, timber frame, metal structure. The centre-to-centre

distances between fasteners on aluminium profiles are defined by a combination of factors: wind zone, orography, roughness and height of the building.

Information on distances between fixings is available on our website.

HORIZONTAL - SILVA

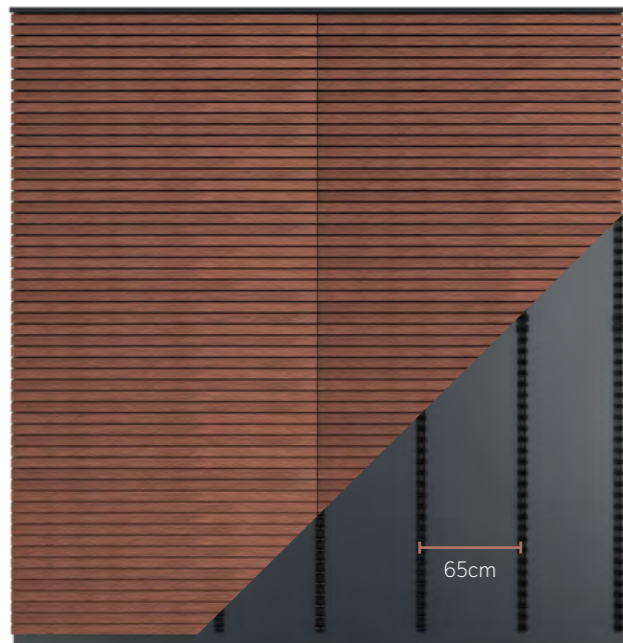

VERTICAL - ANTA

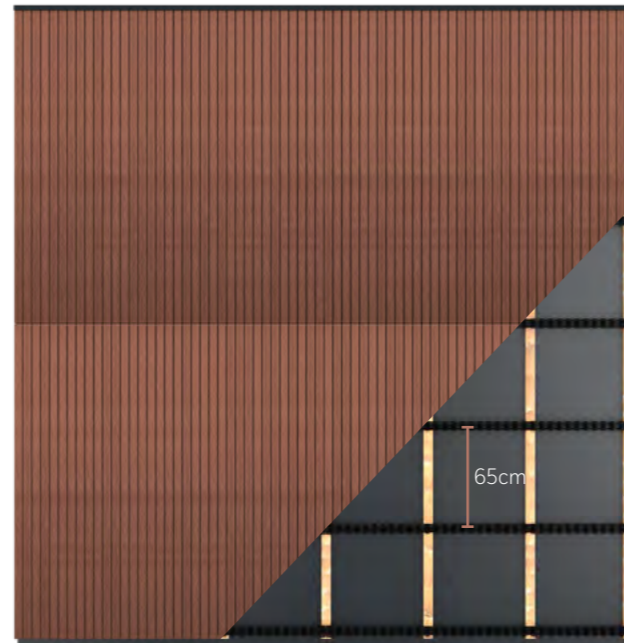

The Silva S range of narrow boards are recommended for horizontal installation. These profiles are milled at an angle to encourage water drainage. Several wood varieties and board widths are available.



The Anta S range refers to boards that are recommended for vertical installation. These profiles are planed with straight edges. Several wood types and board widths are available.

EXAMPLES OF POSSIBLE CONFIGURATIONS

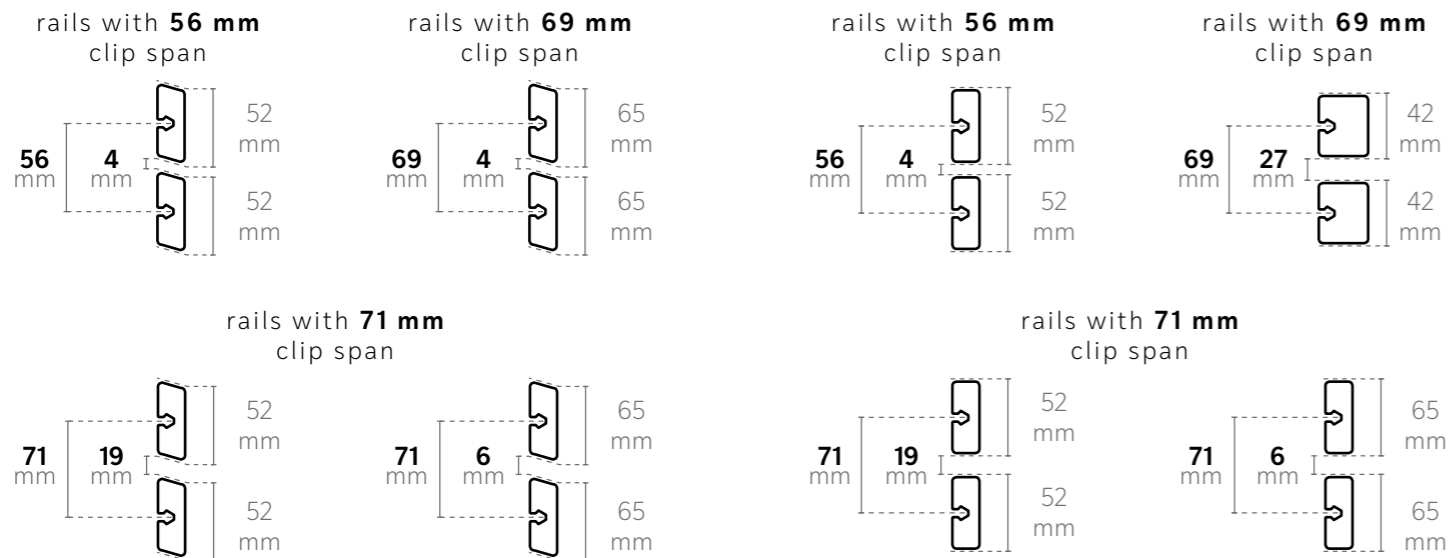

UNIQUE POSSIBILITIES

Variable geometry

The Varibo range includes the three MOSO® Bamboo X-treme® profiles, which are recommended to be installed vertically, as these profiles are planed with straight edges.

Thanks to the dedicated rail that enables you to combine different widths according to the Varibo rhythm, it is possible to easily offer a unique design to the facade.



3D Cladding

Thanks to the Anta S Thermo Spruce line, it is also possible to vary the thickness of the boards. Combining the two board styles adds dimension and character to the facade by creating a 3D relief.

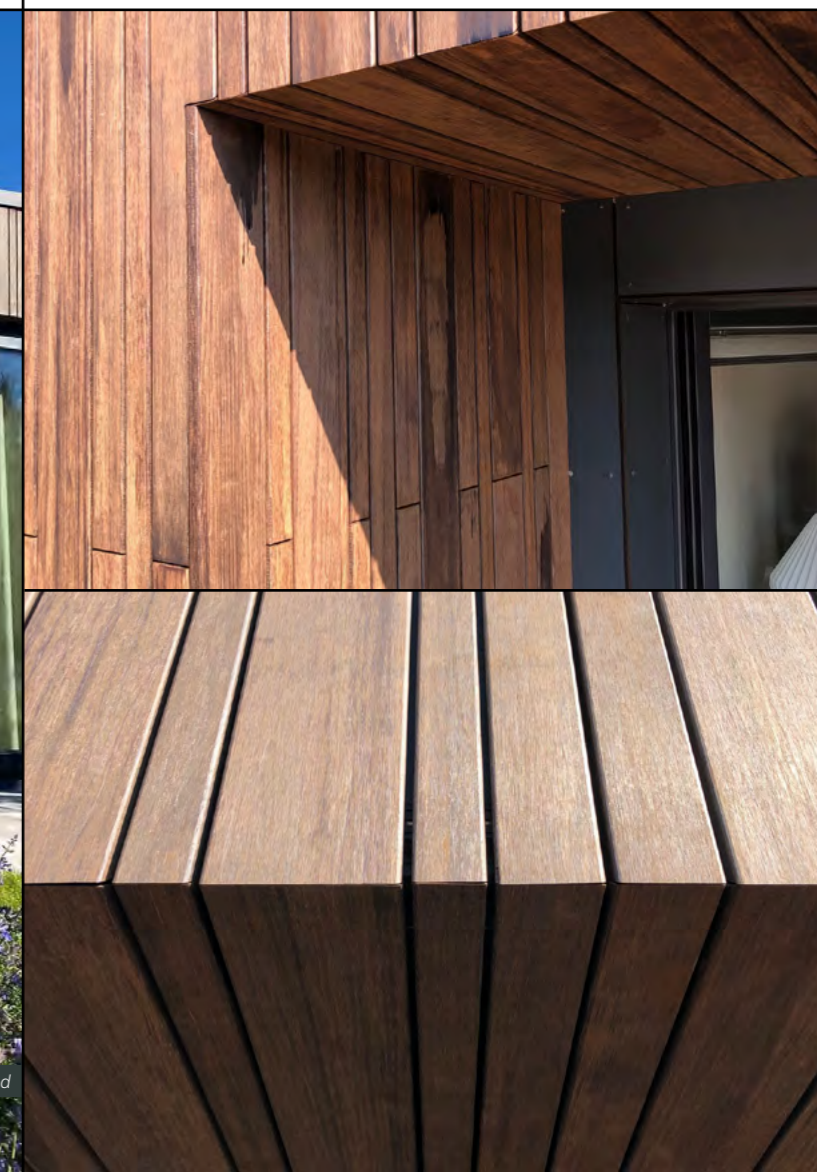

Flat rail / MOSO® Bamboo X-treme® / © Awood

MADE-TO-MEASURE PROJECTS

With the Grad® system, it is possible to create highly customised façades.

Thanks to our precise in-house clip application technology, we can quickly configure and produce made-to-measure rails in any quantity.

With our system, our designers can vary the spacing between clips. These dimensions can be uniform or follow a predefined pattern, for example in the case of boards with different widths.

These requests are subject to the process described below:

PROCESS

1. Define your needs regarding the choice of board and rail profiles and spacing
2. Approval from our design office and creation of your project plans
3. Approval of the project plans by you and your client
4. Acknowledgement of receipt of your order
5. Production begins
6. Preparation and delivery within 3 weeks

CUSTOM ALUMINIUM TREATMENTS

Our rails are extruded in standard shapes from 6060 T6 grade aluminium.

A different grade can be made to order. Similarly, custom surface treatments such as powder coating or anodising are available.

Please do not hesitate to contact your sales representative with any custom design requests.

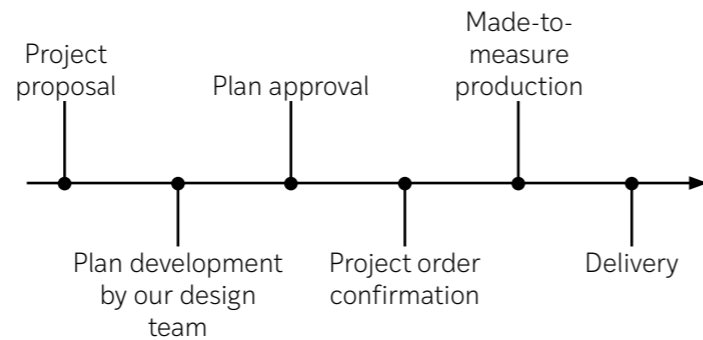

Top Link



Clip Grip



Wedge clip



Removable Grad® Clip



Half-clip



Thermo-Pine Corner Profile

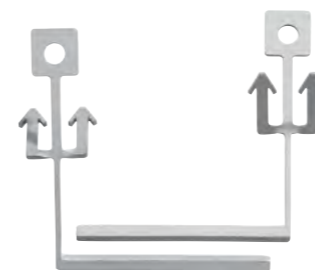

Dismantling keys

ACCESSORIES

REF	DESCRIPTION	SALES UNIT	QTY/PALLET
1488	TOP LINK 56 Rail connector for 56/124 mm clip spacing	Bag of 20 pcs	10 bags
1489	TOP LINK 71 Rail connector for 71 mm clip spacing	Bag of 20 pcs	10 bags
2784	TOP LINK 46 Rail connector for 46 mm clip spacing	Bag of 20 pcs	10 bags
2785	TOP LINK 51 Rail connector for 51 mm clip spacing	Bag of 20 pcs	10 bags
REF	DESCRIPTION	SALES UNIT	QTY/PALLET
2973	CLIP GRIP Claw to prevent board slippage	200 pcs	
1486	WEDGE CLIP with fixation screws	Bag of 20 pcs	25 bags
1483	REMOVABLE GRAD® CLIP	Bag of 50 pcs	20 bags
1485	DEMI-CLIP	Bag of 50 pcs	20 bags
2179	GLUE - 310 ML BOTTLE For vertical installation	1 bottle	n/a
968	DISMANTLING KEYS - 120 To remove 120 mm or smaller boards	1 pair	6 pairs
1784	DISMANTLING KEYS - 155 To remove 155 mm boards	1 pair	10 pairs
2589	THERMO PINE CORNER PROFILE 3.8 x 3.8 x 450 cm	1 pc	200 pcs



Flat Rail / Thermo Ash / © Road Architecten

FINISHING PROFILES

When it comes to wood cladding, the treatment of the edges of façade openings has always been a particular challenge.

Comprising a drip edge, to drain water run-off to the outside of the opening, and a side finish, these parts are particularly important for the aesthetics of the finished structure.

The Grad System makes it possible to achieve a perfect finish, both in terms of preserving the surface of the

cladding and aligning the boards. Four aluminium finishing profiles are available to meet the needs of both horizontal and vertical cladding applications.

Designed to be combined with aluminium mounting pieces to be fixed to the façade, these profiles will ensure a perfect finish to your Grad cladding.

Available in stock, we have these profiles finished in RAL 7016, but it is also possible to customise the powder-coated finish in a wide range of colours.

As with the finishing profiles around openings in the façade, there are many possibilities for the treatment of the corners.

In addition to the wood corner profile, two different finishes are possible:
 → A 45° cut
 → Use of an aluminium corner profile: RAL 7016 or powder-coated on request.

Easy to install thanks to the corner brackets, this aluminium profile gives a perfect, modern finish to the corners of the façade.

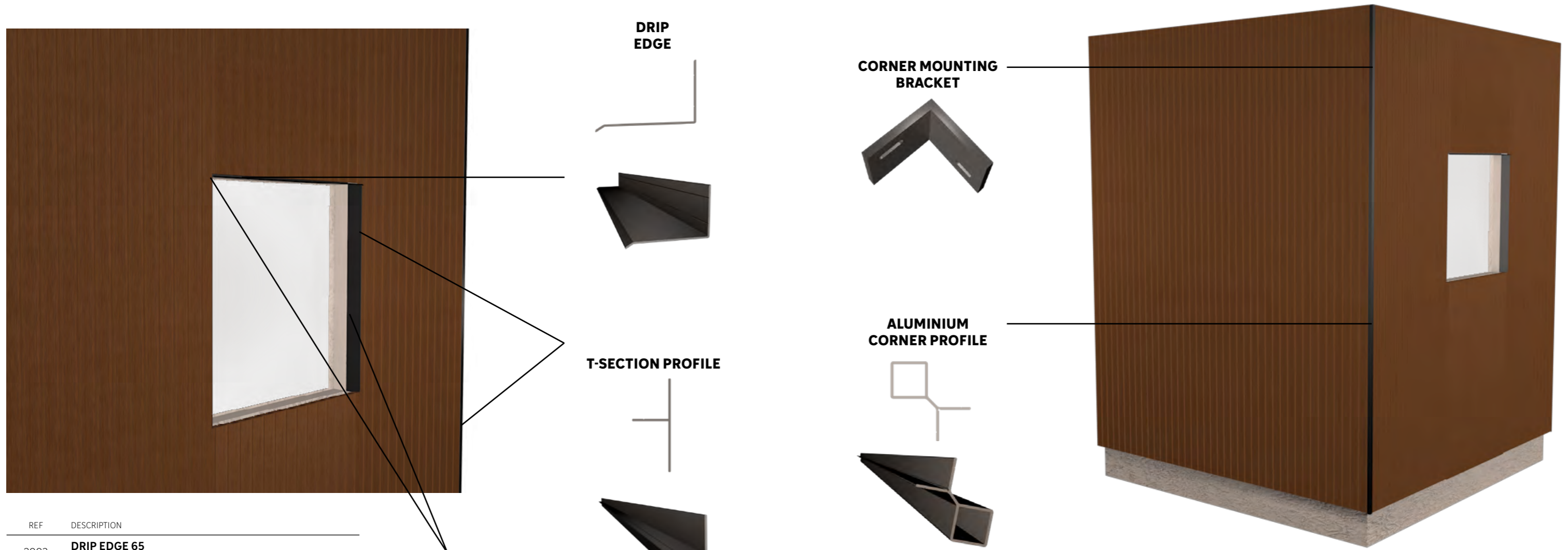

REF	DESCRIPTION
2993	DRIP EDGE 65 For vertical cladding 20 mm
2994	DRIP EDGE 45 For horizontal cladding 20 mm
2995	T-SECTION PROFILE 36 For horizontal cladding 20 mm
2996	T-SECTION PROFILE 56 For vertical cladding 20 mm
2999	ALUMINIUM MOUNTING PLATE
1221	ELASTOMER STRIP 4 mm

REF	DESCRIPTION
2997	ALUMINIUM CORNER PROFILE For cladding 20 mm
2998	CORNER MOUNTING BRACKET
1221	ELASTOMER STRIP 4 mm

FINISHES

Applying a finish to wood cladding offers a number of advantages. This operation will contribute to the decorative aspect of the façades by enhancing the aesthetics of the material.

The application of a saturator will help to even out the colour of the façade. The boards at the bottom of the cladding will therefore benefit from more uniform ageing, continuing to colour match the boards at the top.

For those who want to anticipate the effects of time, the grey finish will give a uniform, trendy grey tint to the facade in anticipation of the natural greying of the wood. What's more, as the finish remains light, it will visibly preserve the unique aesthetic characteristics of the wood's unique aesthetic features, such as its grain, texture, and knots.

If, on the other hand, you want to keep the colour close to the wood's original shade, you can opt for a lightly mottled chestnut finish. This will offer the same benefits of colour uniformity over time, while enhancing the natural appearance of the wood to create an aesthetic façade.

To keep treatments as environmentally-friendly as possible, all the saturators available for the Grad System are water-based. They have the particularity of being well absorbed by the wood, so they protect the upper fibres of the profile against UV rays. At the same time, these wa-

ter-based finishes avoid the film-forming effect of paints and stains, allowing the wood to continue to breathe.

Water-based saturators effectively delay the effects of time, so you can enjoy a façade that looks as good as new for many years. The finish does not peel. It's also practical, requiring no stripping or sanding for homeowners during renovation.



AVAILABLE FINISHES

As the choice of suitable saturators is just as important as their application, we have chosen to work with Fibex. For over 15 years, Fibex has specialised in advising on and applying wood finishes.

In partnership with these experts, we offer two standard finishes from Durieu brand IFAC saturators.

Chestnut brown & Grey

The species concerned are Thermo Spruce, Thermo Ash and Thermo Clear pine. These finishes are available with no minimum quantity.

ORDER PROCEDURE

An average lead time of 4 working weeks should be taken into account for all profile orders with standard brown or grey finishes. The validation of an order is conditional on the validation of the samples.

To order standard samples, please consult our cladding sales guide. To order larger samples, please contact your Grad sales representative.

Other colours are available on request, as well as a matching service if you wish to match your façade with an existing colour on site. The validation of an order is subject to the validation of samples. For all requests concerning these services, please contact your Grad sales representative.

SATURATOR TINTS

Finishes available on request

GREY
Thermo Spruce



GREY
Thermo Ash

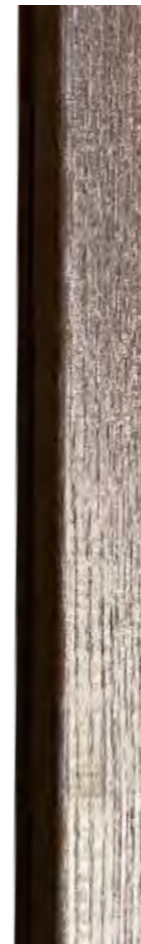

CHESTNUT
Thermo Spruce

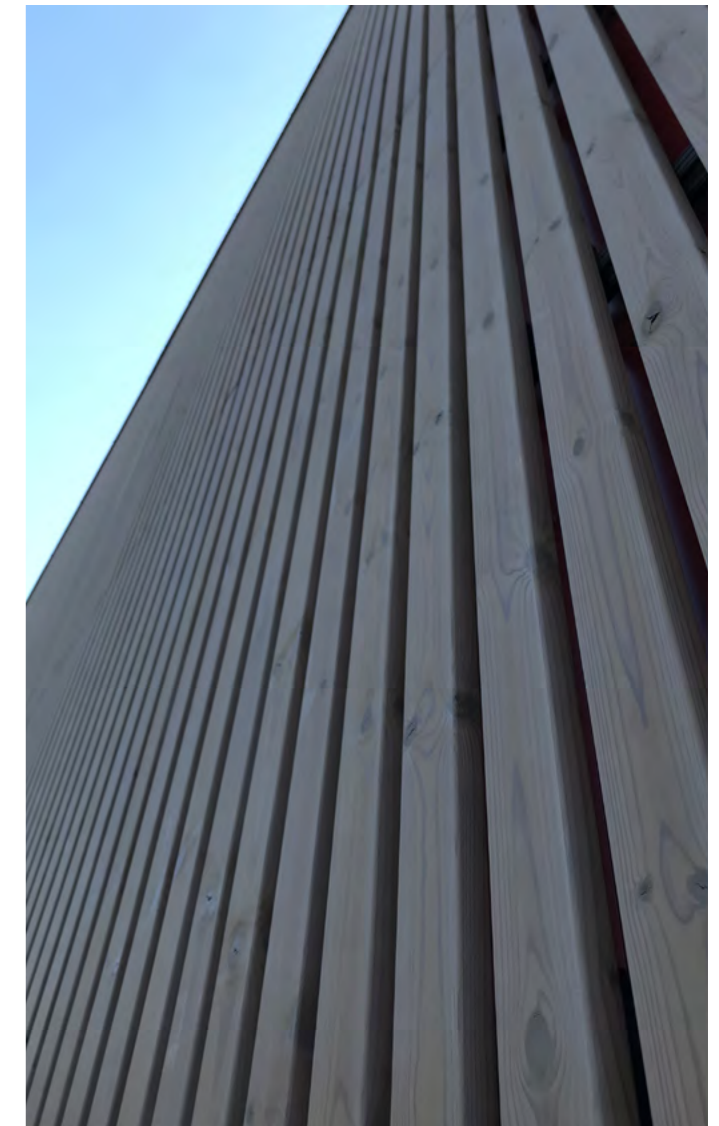

SHOU SUGI BAN



©Maxime Gautier

Japan has always been a country that arouses curiosity through the use of ancestral techniques rooted in respect for mankind and the nature that surrounds it.

Shou Sugi Ban, also known as Yakisugi, is a wood-burning technique that involves burning off the top of a wooden plank to improve its durability.

Shou Sugi Ban is a woodworking technique based on the Buddhist philosophy of 'Wabi-Sabi'. This philosophy seeks to bring out the imperfections and flaws created by the passage of time. Originally, Shou Sugi Ban was used to protect Japanese homes from harsh weather conditions, including heavy rainfall. In the 2000s, this method was popularised in Canada and then in the Nordic countries.

This ancient technique offers considerable advantages in terms of wood durability and maintenance. Carbonisation offers protection against wood mould and oxygenation, making the wood resistant over time. What's more, the carbonised layer will reinforce the wood's resistance to fire and insects.



©Maxime Gautier

AVAILABLE FINISHES

Although simple on paper, the Shou Sugi Ban method requires meticulous treatment and a thorough knowledge of wood.

We have chosen to work with the most renowned company in the field of burnt wood: Zwarthout.

One of the pioneers of Shou Sugi Ban in Europe, Zwarthout was founded in 2012. Over the years, the master burners have developed unique expertise in a wide range of wood species and finishes, from deep black to delicate brown, with different levels of brushing to create a unique tactile appearance.

Grad has chosen Marugame as its standard finish, available on Accoya®.



**zwart
hout**
Shou Sugi Ban



©Maxime Gautier



©Maxime Gautier

ORDER PROCEDURE

Please allow an average of 5 working weeks for any order of standard profile Marugame.

To order standard samples, please consult our cladding sales guide.

To order larger samples, please contact your Grad sales representative.

Other finishes are available on request. The validation of an order is conditional on the validation of the samples. For all requests concerning these services, please contact your Grad sales representative.



©Maxime Gautier

OTHER APPLICATIONS

INTERIOR CLADDING:

- Endless design possibilities: width, thickness, spacing
- Can be used with a wide range of complementary species: Oak, Beech
- Can be combined with MDF, aluminium or medium panels in strip or panel format
- Lightweight system: approximately 1kg/m² of structure
- Open joint profiles can be dismantled
- Perfect spacing and alignment

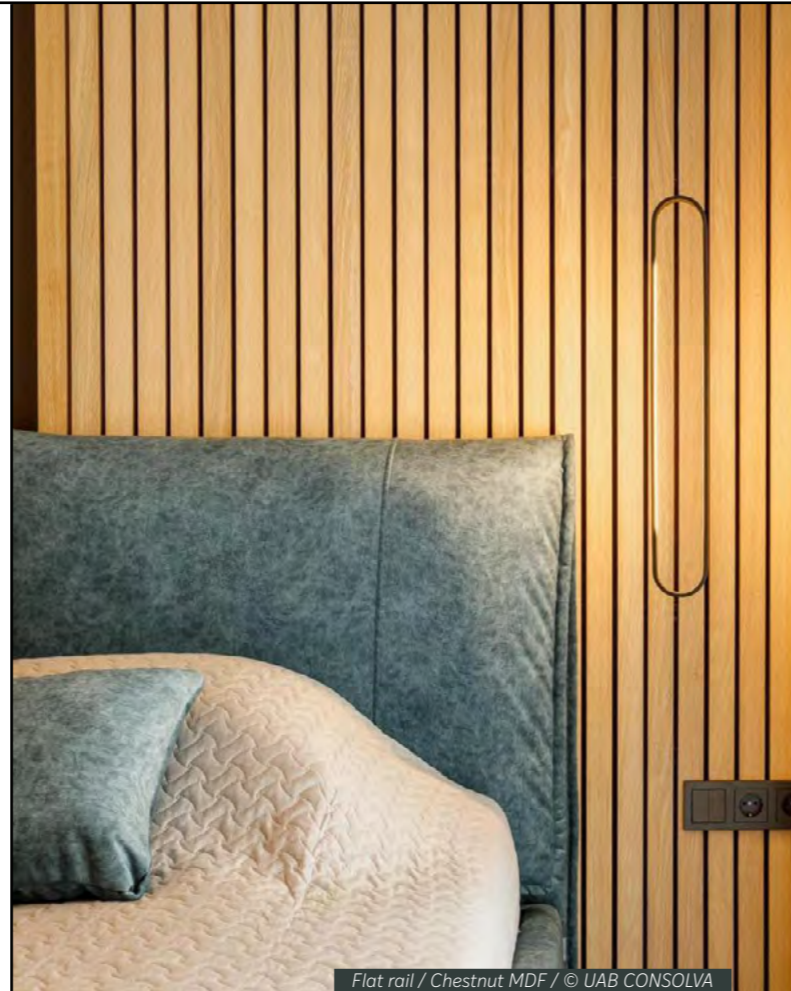

Flat rail / Chestnut MDF / © UAB CONSOLVA

CLADDING FOR GATES AND FENCING:

- Thin, lightweight profiles
- Easy to install
- Possibility of varying cladding widths and thicknesses for infinite customisation
- Vertical and horizontal installation
- Many compatible wood species



Flat rail / Thermo Limba / © Landgoed Living

CEILING CLADDING:

- Easy handling: lightweight aluminium profile
- Rigid rail up to 4m
- Boards can be removed for technical access
- Pull-out resistance up to 280 kg per fixation
- Numerous types and materials available: wood, aluminium, MDF
- Design office available to support projects

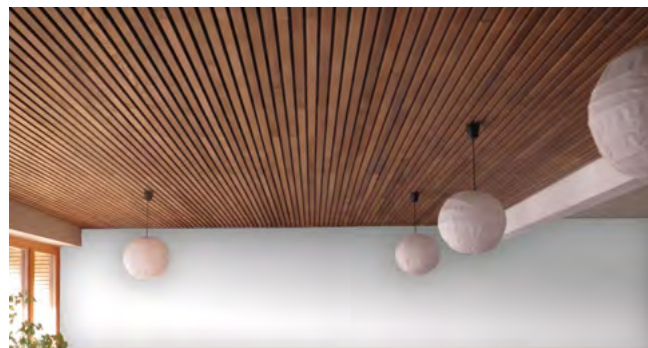

Start rail / Accoya / © Dolle Nordics

MODULAR CLADDING:

- Lightweight system: 630 g/ml
- Easily fix profiles to walls
- Durable: no contact between boards & structure
- Rapid integration into the production line
- Easy, accessible and quick installation thanks to installation guides
- Many compatible profiles and wood species

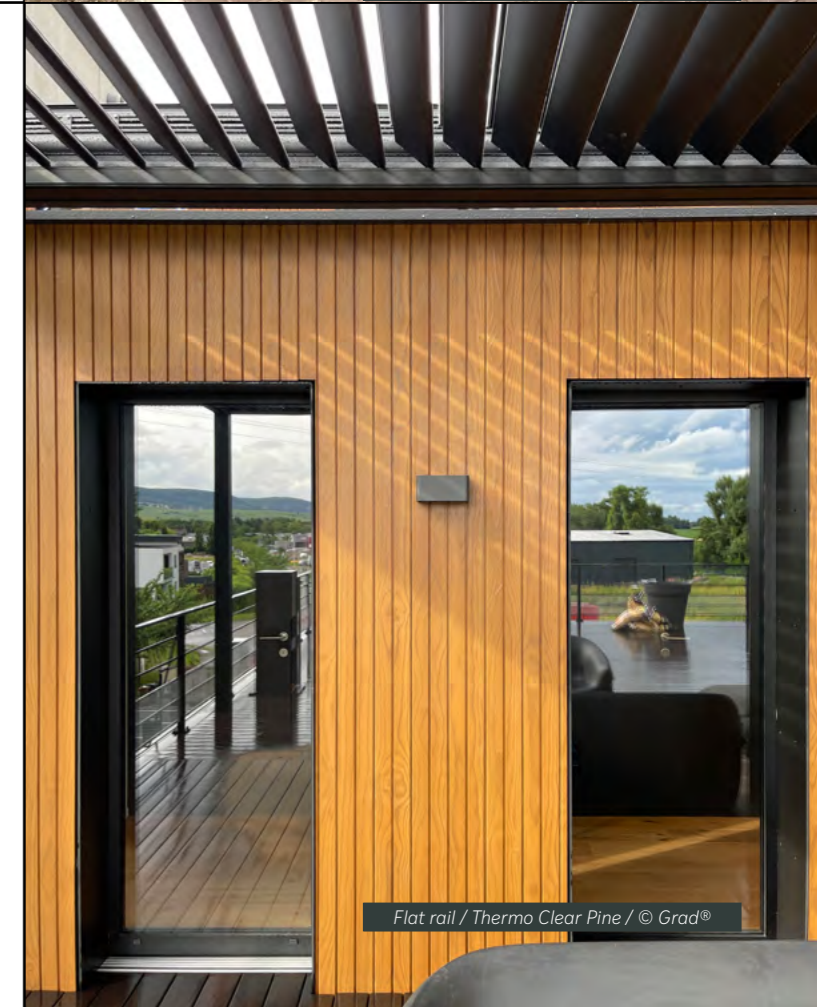

Flat rail / Thermo Clear Pine / © Grad®



→ 05

CLADDING BOARDS



Flat rail / Thermo Spruce / © Grad



THERMO SPRUCE

Picea Abies
Thermally modified wood.

Without the addition of chemicals, this thermal treatment combines steam and heat to permanently modify the internal structure of the wood.

The durability and stability of the material are greatly improved. Its appearance is modified to take on a light honey colour.

Wood from PEFC-certified farms.
Low thermal and acoustic conductivity
Sawfelling quality; 2 to 6 knots per metre.
Profile 20/65 brushed

Durability class 1

- Planed profile with straight edges in the **ANTA S** range
- Planed profile with 30° edges in the **SILVA S** range
- **Square** profile

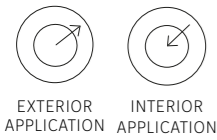

PROFILES

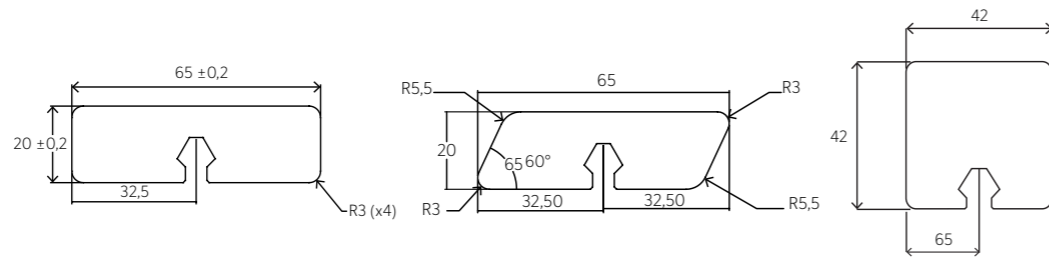
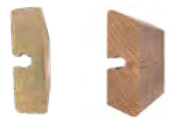

© James R. Salomon

THERMO SPRUCE	REFERENCE	DESCRIPTION
THS 2.0x6.5x300 cm	2847	ANTA S
THS 2.0x6.5x330 cm	2849	ANTA S
THS 2.0x6.5x360 cm	2860	ANTA S
THS 2.0x6.5x390 cm	2861	ANTA S
THS 2.0x6.5x420 cm	2862	ANTA S
THS 2.0x6.5x480 cm	2863	ANTA S
THP 4.2x4.2x300 cm	2627	ANTA S
THP 4.2x4.2x330 cm	2749	ANTA S
THP 4.2x4.2x360 cm	2628	ANTA S
THP 4.2x4.2x390 cm	2629	ANTA S
THP 4.2x4.2x420 cm	2630	ANTA S
THS 2.0x6.5x300 cm	2848	SILVA S
THS 2.0x6.5x330 cm	2850	SILVA S
THS 2.0x6.5x360 cm	2854	SILVA S
THS 2.0x6.5x390 cm	2855	SILVA S
THS 2.0x6.5x420 cm	2856	SILVA S
THS 2.0x6.5x480 cm	2857	SILVA S

FINISHES
Finishes available upon request

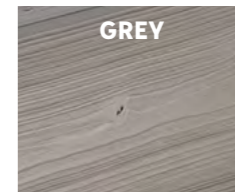

WEATHERING
*depending on conditions and location



- **Maximum centre distance** for private use **65 cm**
- Subject to availability
- Photos non-contractual
- Public project: please contact us

Up to **15 years warranty**, subject to manufacturer's conditions, more features and quality criteria available on our website www.grad-system.com



© Will Johnson



© Erin Feinblatt



© James R. Salomon

THERMO CLEAR PINE

Pinus radiata

Without the addition of chemicals, this thermal treatment combines steam and heat to permanently modify the internal structure of the wood.

The durability and stability of the material are greatly improved. Its appearance is modified to take on a light honey colour.

PEFC certified wood
 Little wood dialation or shrinkage
 Low density: high insulating capacity
 Wood species with very few knots
 Smooth profile

- Planed profile with straight edges in the **ANTA S** range
- Planed profile with 30° edges in the **SILVA S** range

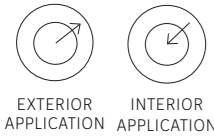

PROFILES

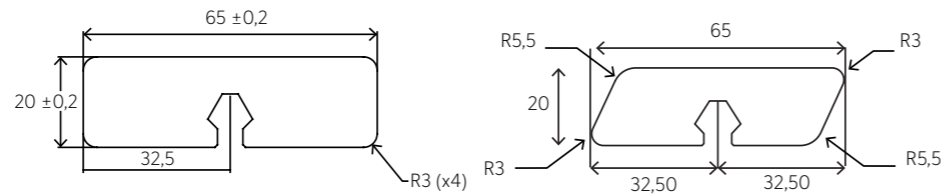

PVL Architectes

BENEFITS OF CLEAR PINE

- Colour similar to exotic woods
- Lengths up to 4.80m
- Aesthetic grain
- Ash-grey patina appears with age

FINISHES

Finishes available upon request

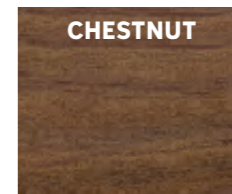
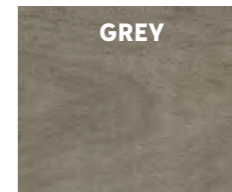

WEATHERING

*depending on conditions and location

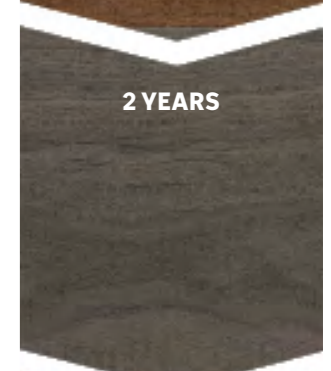
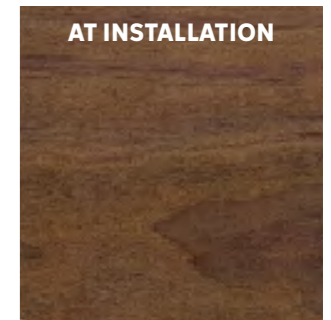

THERMO CLEAR PINE

	REFERENCE	DESCRIPTION
Clear pine 2.0 x 6.5 x 300 cm	2847	ANTA S
Clear pine 2.0 x 6.5 x 360 cm	2848	ANTA S
Clear pine 2.0 x 6.5 x 420 cm	2849	ANTA S
Clear pine 2.0 x 6.5 x 480 cm	2850	ANTA S
Clear pine 2.0 x 6.5 x 420 cm	2939	ANTA S
Clear pine 2.0 x 6.5 x 300 cm	2937	SILVA S
Clear pine 2.0 x 6.5 x 360 cm	2938	SILVA S
Clear pine 2.0 x 6.5 x 480 cm	2940	SILVA S

- **Maximum centre distance** for private use **65 cm**
- Subject to availability
- Photos non-contractual
- Public project: please contact us

Up to **15 years warranty**, subject to manufacturer's conditions, more features and quality criteria available on our website www.grad-system.com



© Elvo Jakobson

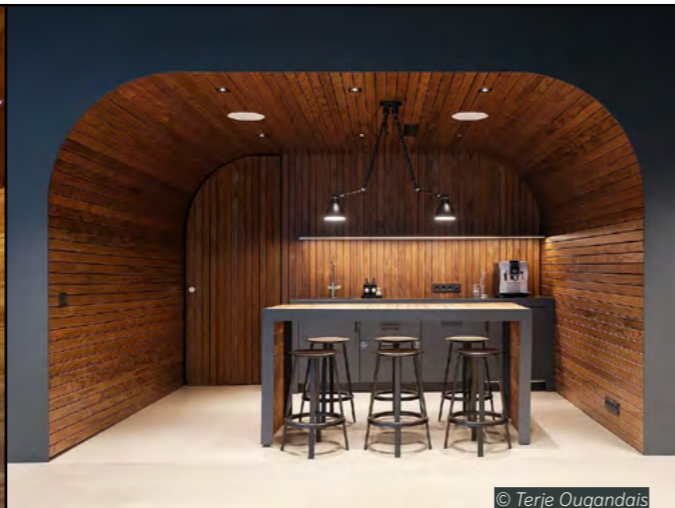

© Terje Ougandais



© Terje Ougandais



MOSO®

Heat-treated bamboo fibres, compressed to high-density.

This two-part treatment improves stability and durability for exterior applications.

MOSO® Bamboo X-treme® est thermo-treated to 200°C
 Very hard and fire resistant
 Puncture and scratch resistant
 An eco-friendly alternative to the over-use of tropical hardwoods.
 Ideal for public projects.
 No knots

Durability class 0

Profile : smooth, unsaturated Sikkens



EXTERIOR APPLICATION

PROFILES

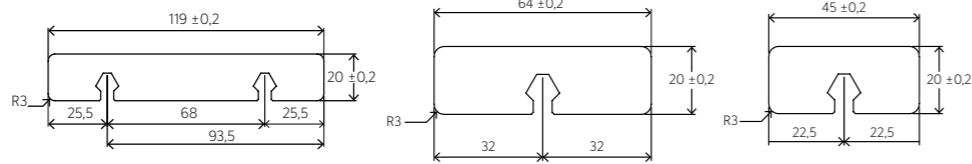

Flat rail / MOSO® Bamboo X-treme® / © Ossip Van Duivenbode



Flat rail / MOSO® Bamboo X-treme® / © Ossip Van Duivenbode

BENEFITS OF MOSO®

- High density
- Optimal durability and stability
- Variable widths for customisation
- Numerous certifications available



Flat rail / MOSO® Bamboo X-treme® / © Awood



Flat rail / MOSO® Bamboo X-treme® / © Grad



Flat rail / MOSO® Bamboo X-treme® / © TIM Exclusive Gardens

WEATHERING

*depending on conditions and location

AT INSTALLATION

AFTER 2 YEARS

- **Maximum centre distance** for private use **65 cm**
- Subject to availability
- Photos non-contractual
- Public project: please contact us

Up to **25 years warranty**, subject to manufacturer's conditions, more features and quality criteria available on our website www.grad-system.com

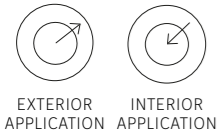

EXTERIOR APPLICATION INTERIOR APPLICATION

PROFILES



Anta

Silva

THERMO ASH

Fraximus excelsior.

Without adding chemical products, the thermal treatment combines water vapour and heat to modify the internal structure of the wood.

With this treatment, the durability and stability of the material are greatly improved and the wood's appearance is modified to take on a dark brown hue.

- Little expansion or shrinkage of the wood
- High density
- Wood species with very few knots
- Smooth profile

Durability class 1

- Planned profile with straight edges in the **ANTA S** range
- Planned profile with 30° edges in the **SILVA S** range

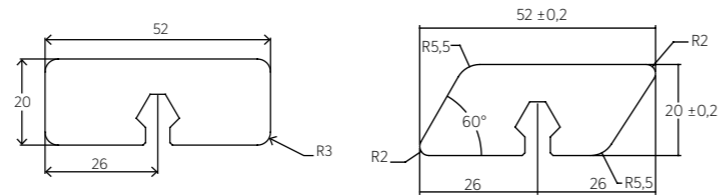

Flat rail / Thermo Ash / © Awood

BENEFITS OF THERMO ASH

- High density
- Exceptional grain aesthetics
- Silvery grey patina with ageing

THERMO ASH

	REFERENCE	DESCRIPTION
THF 2.0x5.2x210 cm	1383	ANTA S
THF 2.0x5.2x240 cm	1384	ANTA S
THF 2.0x5.2x270 cm	1385	ANTA S
THF 2.0x5.2x300 cm	1388	ANTA S
THF 2.0x5.2x210 cm	1432	SILVA S
THF 2.0x5.2x240 cm	1433	SILVA S
THF 2.0x5.2x270 cm	1434	SILVA S
THF 2.0x5.2x300 cm	1437	SILVA S
THF 2.0x5.2x180 cm	1387	ANTA S
THF 2.0x5.2x210 cm	1383	ANTA S
THF 2.0x5.2x240 cm	1384	ANTA S
THF 2.0x5.2x270 cm	1385	ANTA S
THF 2.0x5.2x300 cm	1388	ANTA S
THF 2.0x5.2x150 cm	1435	SILVA S
THF 2.0x5.2x180 cm	1436	SILVA S

- **Maximum centre distance** for private use **65 cm**
- Subject to availability
- Photos non-contractual
- Public project: please contact us

Up to **20 years warranty**, subject to manufacturer's conditions, more features and quality criteria available on our website www.grad-system.com

FINISHES
Finishes available upon request

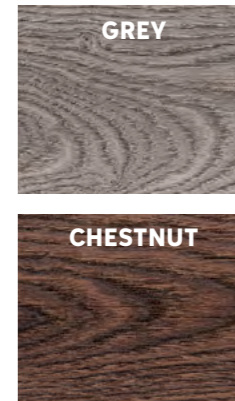

WEATHERING
*depending on conditions and location



Flat rail / Thermo Ash / © Elvo Jakobson



Flat rail / Thermo Ash / © Carpentier



Flat rail / Thermo Ash / © Carpentier



KEBONY®

Pinus Radiata.
Furfurylation treatment.

Injection of a plant-derived component which, after heat treatment, modifies the molecular structure of the wood. This significantly increases its density, durability and stability. Finish is similar to that of the finest exotic woods.

Wood from PEFC-certified plantations.
Little expansion or shrinkage of the wood
Very high weather resistance
Wood species with very few knots
Smooth profile

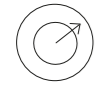

EXTERIOR APPLICATION



INTERIOR APPLICATION

PROFILES

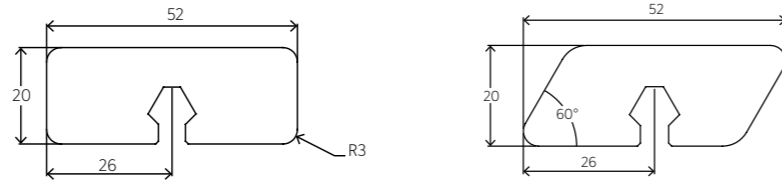

- Planed profile with straight edges in the **ANTA S** range
- Planed profile with 30° edges in the **SILVA S** range



Kebony / © Kristian Alveo

BENEFITS OF KEBONY®

- Colour similar to exotic woods
- Plantation forests
- High density
- Eco-friendly production
- Lengths up to 4.80m
- Modern ash-grey patina

KEBONY®	REFERENCE	DESCRIPTION
KEB 2.0x5.2x300cm	2843	ANTA S
KEB 2.0x5.2x360 cm	2844	ANTA S
KEB 2.0x5.2x420 cm	2845	ANTA S
KEB 2.0x5.2x480 cm	2846	ANTA S
KEB 2.0x5.2x300 cm	2626	SILVA S
KEB 2.0x5.2x360 cm	2838	SILVA S
KEB 2.0x5.2x420 cm	2839	SILVA S
KEB 2.0x5.2x480 cm	2840	SILVA S

- **Maximum centre distance** for private use **65 cm**
- Subject to availability
- Photos non-contractual
- Public project: please contact us

Up to **30 years warranty**, subject to manufacturer's conditions, more features and quality criteria available on our website www.grad-system.com

WEATHERING

*depending on conditions and location

AT INSTALLATION

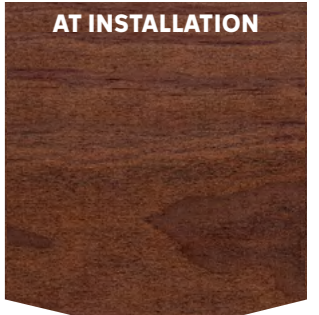

2 YEARS



5 YEARS



Flat rail / Kebony / © Rudy De Keyser

ACCOYA®

Pinus radiata
Modified by acetylation.
Available in two finishes: Accoya Natural and Accoya Color Grey

Acetylation is a modification that transform the wood's OH molecules into acetyl molecules, which do not bind with water molecules.

Wood from FSC®-certified plantations.
Extremely stable wood: average tangential stability coefficient of 1.5%.
Wood species with very few knots
Smooth profile

- Planed profile with straight edges in the **ANTA S** range
- Planed profile with 30° edges in the **SILVA S** range

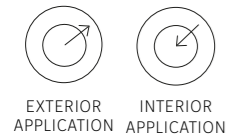

PROFILES

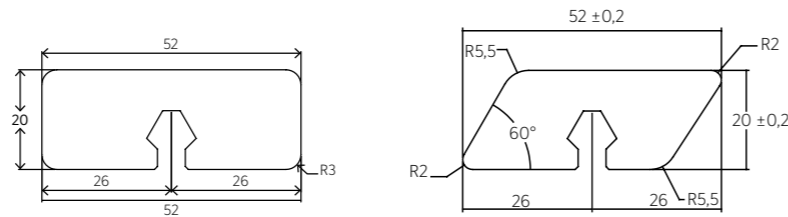

Flat rail / Accoya natural / © Lalavingdesign



© Accoya Color Gray



Flat rail / Accoya natural/ © Lalavingdesign



© Accoya Color Gray

BENEFITS OF ACCOYA®

- Exceptional durability and stability
- Low thermal conductivity
- Lengths of up to 4.80m
- Eco-friendly design
- Colour life is at least 3-4x longer than tropical hardwoods
- Since 2010, Accoya® has been certified Cradle-to-Cradle Gold certification, which recognises the eco-design of a product, taking into account its recyclability.
- Accoya Color: coloured through from surface to core, Accoya Color Grey is the only solid wood in the world to possess this property

ACCOYA® NATURAL

REFERENCE	DESCRIPTION
ACC 2.0x5.2x150cm	2739 ANTA S
ACC 2.0x5.2x210cm	2740 ANTA S
ACC 2.0x5.2x240cm	2731 ANTA S
ACC 2.0x5.2x300 cm	1379 ANTA S
ACC 2.0x5.2x360 cm	1380 ANTA S
ACC 2.0x5.2x420 cm	1381 ANTA S
ACC 2.0x5.2x480 cm	1728 ANTA S
ACC 2.0x5.2x210 cm	2825 SILVA S
ACC 2.0x5.2x240 cm	2824 SILVA S
ACC 2.0x5.2x300 cm	1428 SILVA S
ACC 2.0x5.2x360 cm	1429 SILVA S
ACC 2.0x5.2x420 cm	1430 SILVA S
ACC 2.0x5.2x480 cm	1748 SILVA S

- **Maximum centre distance** for private use **65 cm**
- Subject to availability
- Photos non-contractual
- Public project: please contact us

Up to **50 years warranty**, subject to manufacturer's conditions, more features and quality criteria available on our website www.grad-system.com

WEATHERING

*depending on conditions and location



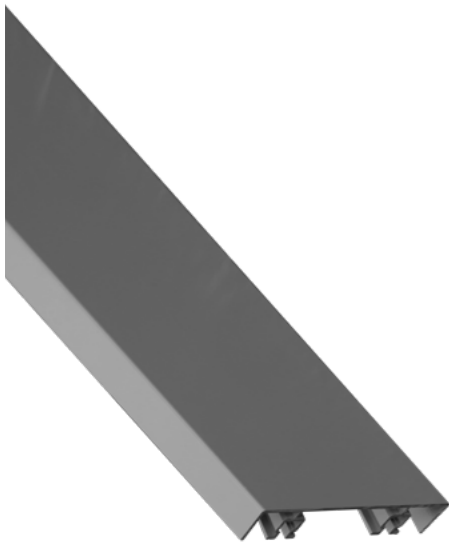

ALUMINIUM

Aluminium profile for cladding and ceilings

ALUMINIUM	REFERENCE
Aluminium Profile 2.0x4.5x400 cm	2866
Aluminium Profile 2.0x9.0x400 cm	2864
Aluminium Profile 4.0x4.0x400 cm	2865

BENEFITS OF ALUMINIUM CLADDING

- Extreme durability and stability
- Unrivalled design variability
- Incredibly lightweight
- Resistance to harsh environments
- Powder coating on request

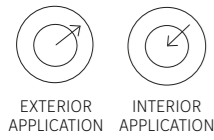

EXTERIOR APPLICATION INTERIOR APPLICATION



All RAL colors available upon request

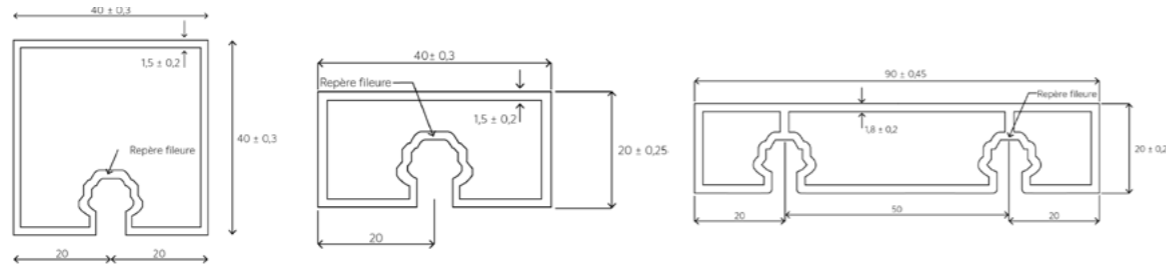

COMPATIBILITY TABLE

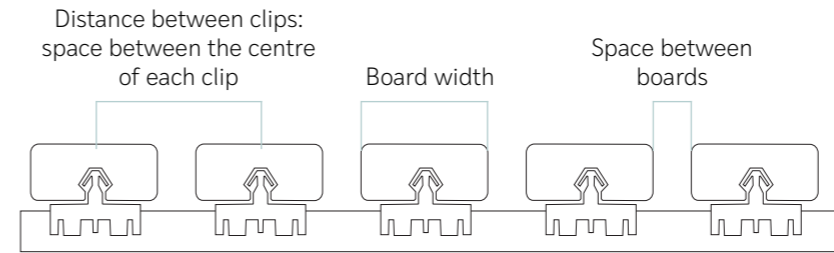

BOARD SPACING ACCORDING TO RAIL AND BOARD CHOICE (MM)

	2480	2191	1188	1799	2632	1822	2414	1792	1187	1185
BOARD WIDTH	FLAT RAIL VARIBO2 1968 MM	FLAT RAIL 46 LG 1978 MM	FLAT RAIL 56 LG 1960 MM	FLAT RAIL 51 LG 1989 MM	FLAT RAIL 58.5 LG 1978 MM	FLAT RAIL 69 LG 2001 MM	FLAT RAIL 69 LG 3933MM	FLAT RAIL 70 LG 1960 MM	FLAT RAIL 71 LG 1988 MM	FLAT RAIL 124 LG 1984 MM
40	-	6	16	11	18,5	29	29	-	31	84
42	-	4	14	9	16,5	27	27	28	29	-
45	-	-	11	6	13,5	24	24	25	26	-
52	-	-	4	-	6,5	17	17	18	19	-
64	-	-	-	-	-	5	5	6	7	-
65	-	-	-	-	-	4	4	5	6	-
90	-	-	-	-	-	-	-	-	-	34
119	-	-	-	-	-	-	-	-	-	5
42-65	-	-	-	-	5	-	-	-	-	-
45-64-119	6	-	-	-	-	-	-	-	-	-

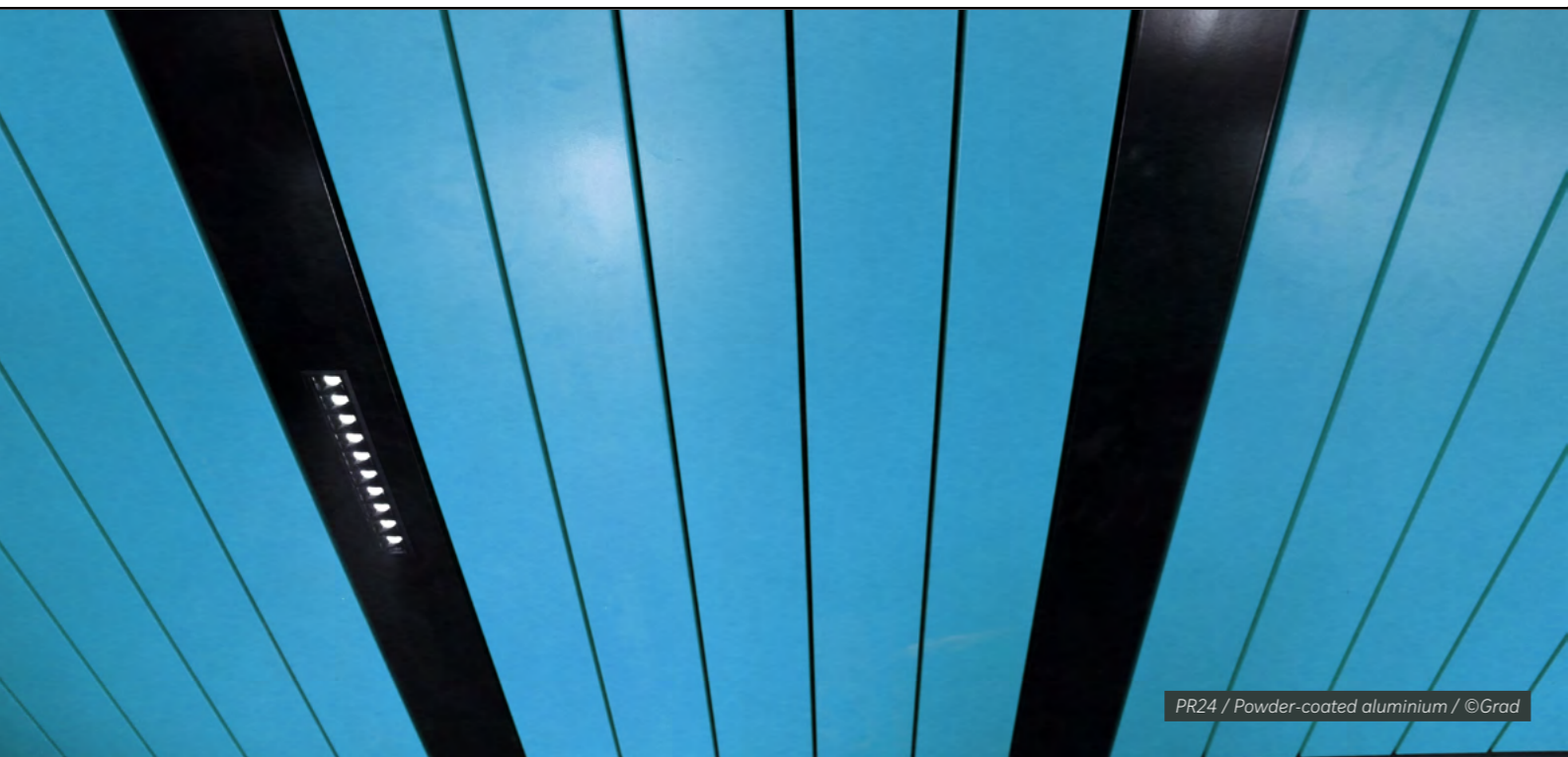

PR24 / Powder-coated aluminium / © Grad

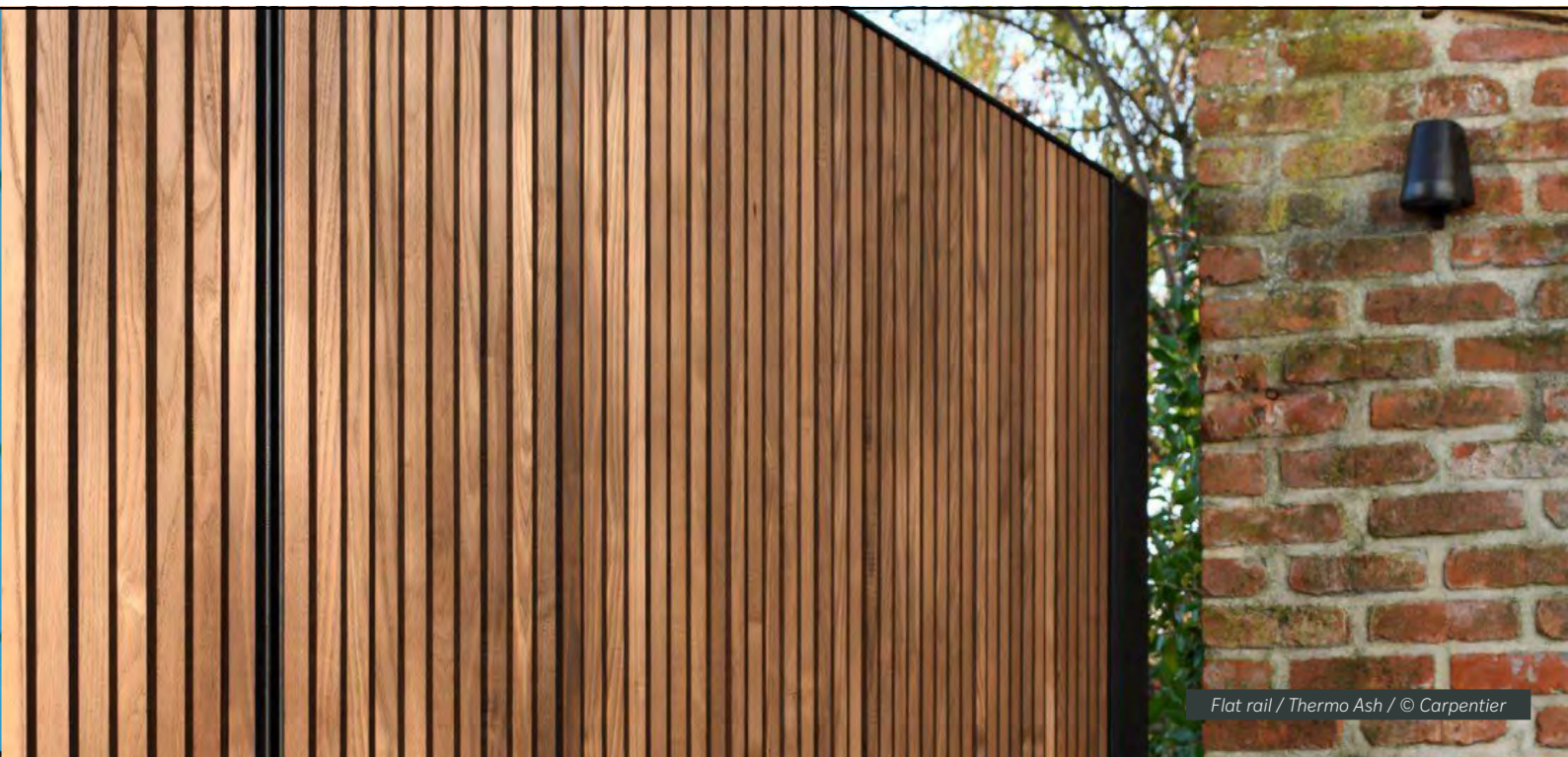

Flat rail / Thermo Ash / © Carpentier

→ 06

FEATURED PROJECTS

Get inspired!



Flat rail / MOSO® Bamboo X-treme® / © Olivr.nl





AARHUS HARBOUR APARTMENTS

Aarhus, Denmark

Project: Cladding
Cladding boards: Thermory Thermo-Pine
Architect: BIG (Bjarke Ingels Group)
Local distributor: Dolle Nordics
Photographer: R. Hjortshøj, Coast Studio
Rail: Flat Rail

↓ The AARHUS project echoes the second largest city in Denmark Aarhus. At the crossroads of the city's bay and harbour, this building, built in 2019, culminates at different heights and offers a breathtaking view of both the city and nature. The architecture of the building is both dynamic and modern and has been designed in such a way as to preserve the existing urban atmosphere of the city of Aarhus. Shaped like two As, the 20-story residential building houses 250 apartments, all with direct ocean views.



↑ To enhance this ambitious project, the Grad® system was adopted for the totality of the building's wood cladding. A solution that fully met the expectations of this project, thanks to our invisible fastening structure guaranteeing perfect drip lines. Thermo-Pine was chosen to give warmth to the angular building.



BLACK

Clichy, France

Project : Cladding

Cladding boards: Accoya© Marugame

Architect: Emmanuel Combarel Dominique Marrec Architectes

Rail : Flat Rail

→ Located on a former industrial site, Black aims to be one of the largest low-carbon buildings in France. The aim of this decarbonised project is to create a green urban campus for AXA IM Alts and Redman. It has been designed to facilitate relationships between spaces, places and people.



← Comprising two independent buildings, one of 31,520 m² on the garden side and the other of 17,170 m² on the courtyard side, it will accommodate three commercial premises, an auditorium and a concierge service. The project will offer 47,890 m² of office space, 314 m² of retail space, 980 m² of bicycle storage, more than 500 parking spaces and will be able to accommodate more than 4,000 people.

↑ Through an environmentally-friendly design, the people involved in this project wanted to forge links between the communities and their environment to create a genuine osmosis between them. Black aims to achieve a number of labels and certifications, including HQE Neuf Exceptional level, BREEAM Excellent, BBCA, E+/C- level E1/C1, Bâtiment Biosourcé, BiodiverCity, Osmoz, R2S and Wirescore.

With this in mind, our Grad system was chosen for the construction of 6,300 m² of burnt Accoya® cladding using the ancestral Japanese technique of Yaki Sugi.

PRIVATE HOME

The Netherlands

Project : Bardage
Cladding boards : MOSO® Bamboo X-treme®
Architect : Bart Van Spee
Local distributor : Awood
Photographer : Ossip Van Duivenbode
Rail: Flat Rail

↓ The breathtaking, eco-friendly SPEEHUIS by SPEE Architects.

SPEE Architects have designed a stunning home that doubles as their workplace, dubbed SPEEHUIS. This innovative design blends in perfectly with the lush forest environment, thanks to its organic aesthetic and use of sustainable materials. What's more, the home and office have an ecological profile, as they are built using bio-based materials.

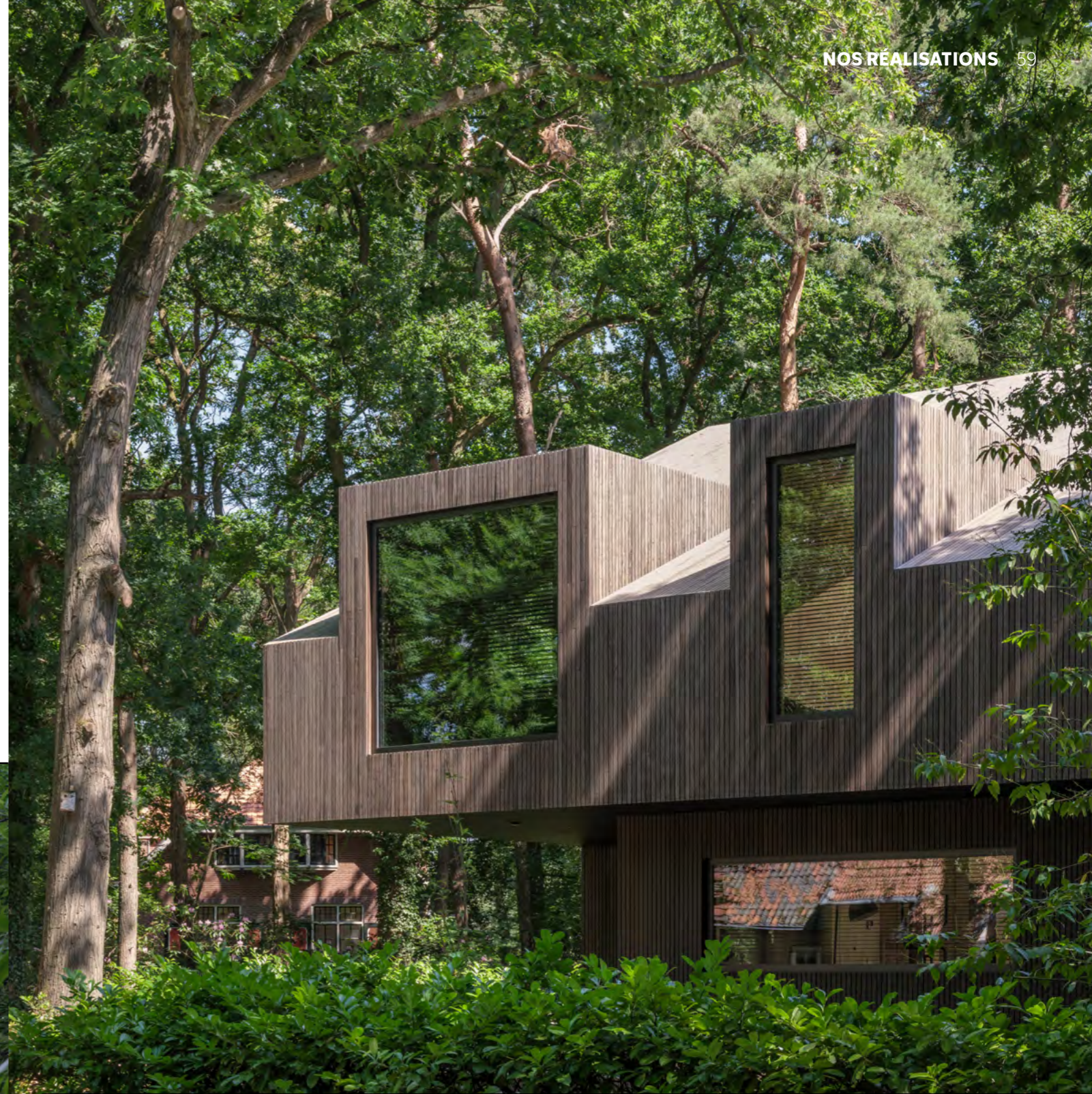

↑ From the outside, SPEEHUIS boasts an attractive façade made up of Bamboo X-treme® boards, which clip onto the Grad system. The client chose the Grad® system because it is quick to install and easy to dismantle.





GRAD® - BURGER & CIE
Z.I. Bois l'Abbesse
68660 LIÈPVRE - FRANCE
+33(0)3 89 58 45 45

WWW.GRAD-SYSTEM.COM

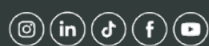

ref CB24EN
artwork Grad® France - 09/2023
photos, illustrations and documentation are
non contractual
please don't litter
Credit cover : Buro Ruijs and Hans Gorter
Credit back cover : Studio Fortuin